



**GENERATOR TYPE ECO 43-2LN/4**

Document : **DS030A/1**  
issue 009 date 01/06/2011

<b>Electrical Characteristics</b>										
Frequency	Hz	50				60				
Voltage (parallel star)	V	380	400	415	440	415	440	460	480	
Rated power class H	kVA	1300	1300	1300	1235	1451	1482	1560	1560	
	kW	1040	1040	1040	988	1161	1186	1248	1248	
Rated power class F	kVA	1200	1200	1200	1140	1339	1368	1440	1440	
	kW	960	960	960	912	1071	1094	1152	1152	
Regulation with	DSR	±1% with any power factor and speed variations between -5% +30%								
Insulation class		H								
Execution		Brushless								
Stator winding		12 ends								
Rotor		with damping cage								
Efficiencies class H	4/4	%	96,1	96	95,8	95,6	95,8	96,3	96,5	96,4
(see graph. for details)	3/4	%	96,5	96,2	96,2	96,1	96,1	96,3	96,7	96,5
	2/4	%	95,1	95	94,9	94,6	95	95,1	95,3	95,2
	1/4	%	92	92	91,8	91,3	92,5	92,5	92,5	92,5
<b>Reactances (f. l.c.l. F)</b>										
	Xd	%	416,6	376	349,3	295,2	467,7	425,1	409,4	376
	Xd'	%	19,7	17,8	16,5	14	22,1	20,1	19,38	17,8
	Xd''	%	9,3	8,4	7,8	6,6	10,4	9,5	9,15	8,4
	Xq	%	192,8	174	161,6	136,6	216,4	196,7	189,5	174
	Xq'	%	192,8	174	161,6	136,6	216,4	196,7	189,5	174
	Xq''	%	21,2	19,1	17,7	15	23,8	21,6	20,8	19,1
	X <sub>2</sub>	%	15,2	13,7	12,7	10,8	17,0	15,5	14,9	13,7
	X <sub>0</sub>	%	4,3	3,9	3,6	3,1	4,9	4,4	4,25	3,9
Short Circuit Ratio	Kcc		0,33	0,38	0,43	0,53	0,24	0,28	0,33	0,38
Time Constants	Td'	sec.	0,271							
	Td''	sec.	0,0184							
	Tdo'	sec.	8,90							
	Tα	sec.	0,026							
Short Circuit Current Capacity		%	>300				>350			
Excitation at no load	Amp.		0,6	0,7	0,8	1	0,4	0,5	0,6	0,7
Excitation at full load	Amp.		3,2	3,3	3,4	3,5	2,9	3	3,1	3,3
Overload (long-term)		%	1 hour in a 6 hours period 110% rated load							
Overload per 20 sec.		%	300							
Stator Winding Resistance (20°C)	Ω		0,0058							
Rotor Winding Resistance (20°C)	Ω		2,800							
Exciter Resistance (20 °C)	Ω		Rotor : 0,130				Stator : 10,63			
Heat dissipation at f.l.c.l.H	W		42206	43333	45595	45473	50891	45553	45264	46606
Telephone Interference			THF < 2%				TIF < 40			
Radio interference			EN61000-6-3, EN61000-6-1. For others standards apply to factory							
Waveform Distors.(THD) at f. load	LL/LN %		1,5 / 1,5							
Waveform Distors.(THD) at no load	LL/LN %		2,4 / 2,4							
<b>Mechanical characteristics</b>										
Protection			IP 21 (other protection on request)							
DE bearing			6324							
NDE bearing			6322							
Weight of wound stator assembly	kg		979							
Weight of wound rotor assembly	kg		759							
Weight of complete generator	kg		2660							
Maximun overspeed	rpm		2250							
Unbalanced magnetic pull at f.l.c.l.F	kN/mm		5,9							
Cooling air requirement	m³/min		90				108			
Inertia Constant (H)	sec.		0,243				0,292			
Noise level at 1m/7m	dB(A)		95 / 84				99 / 89			

All technical data are to be considered as a reference and they can be modified without any notice.

This document is a propriety of Mecc Alte S.p.A.. All rights reserved.

**50 Hz**

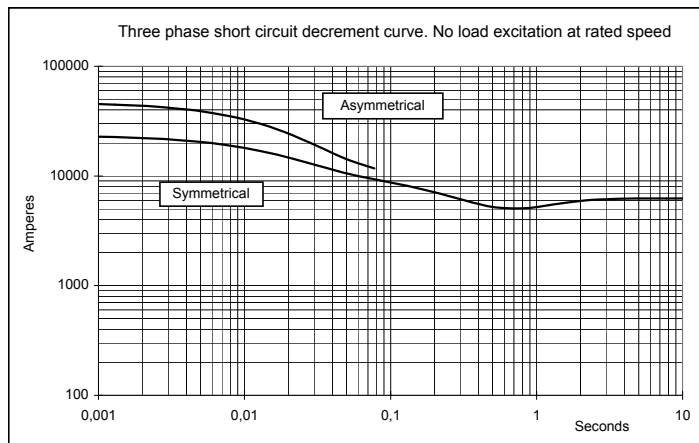
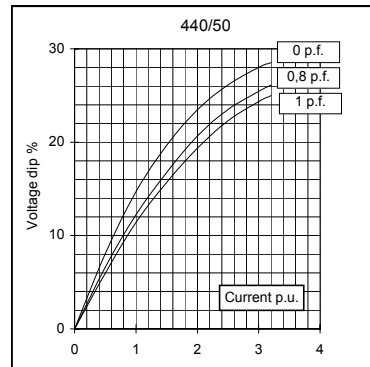
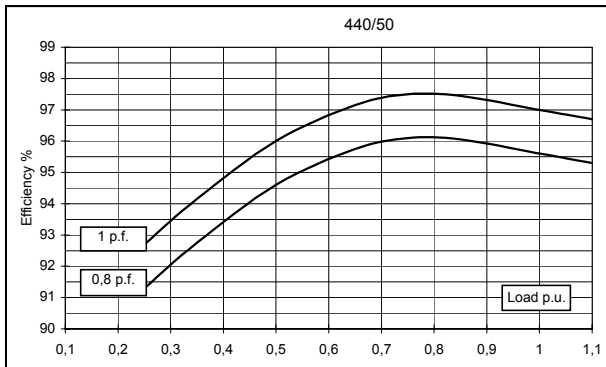
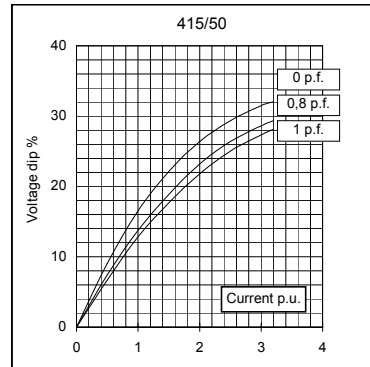
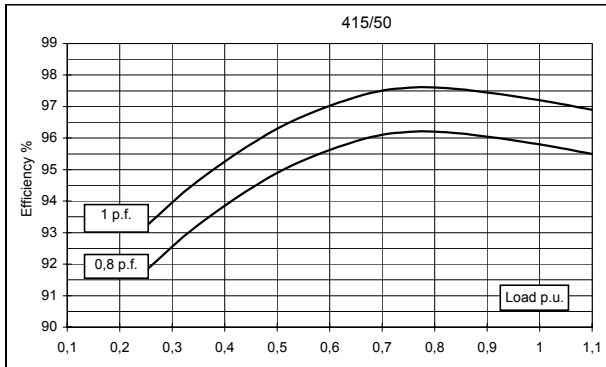
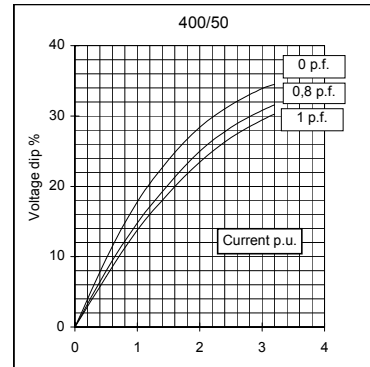
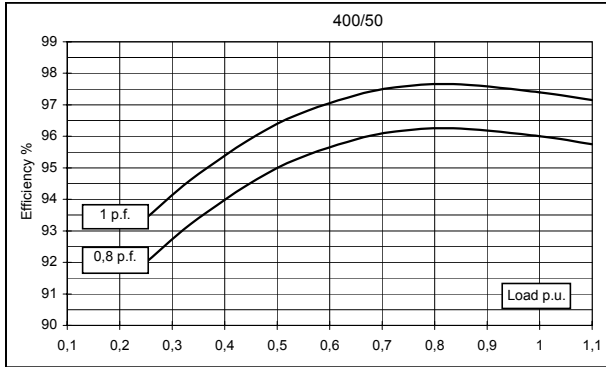
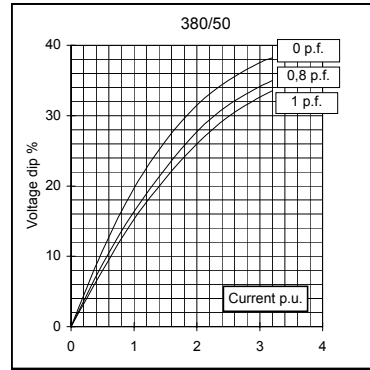
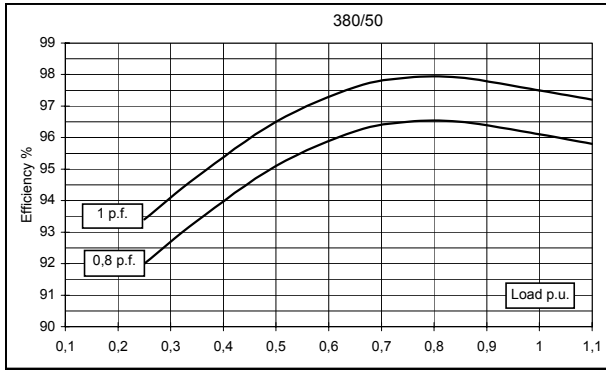

**60 Hz**

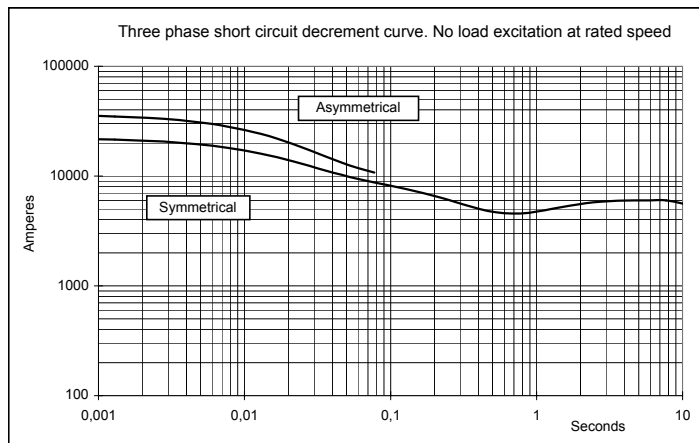
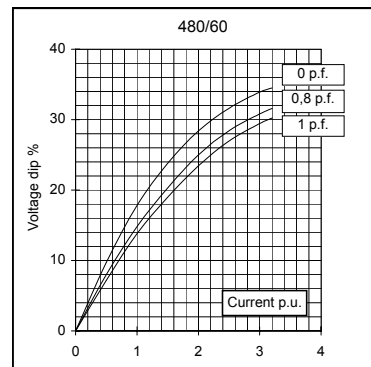
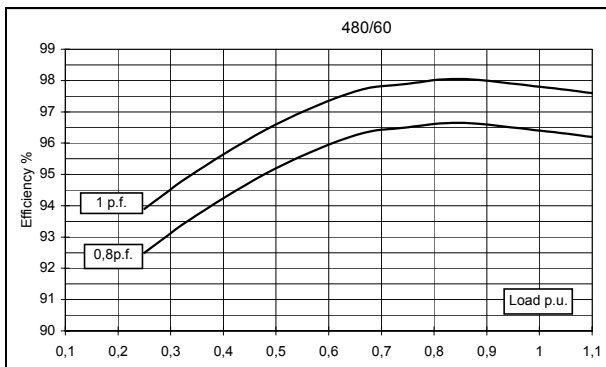
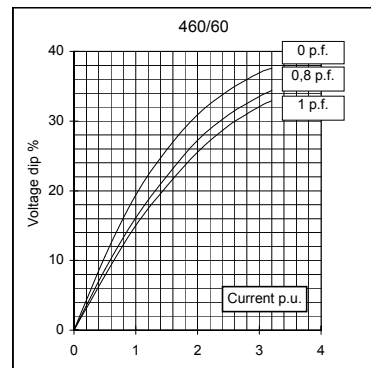
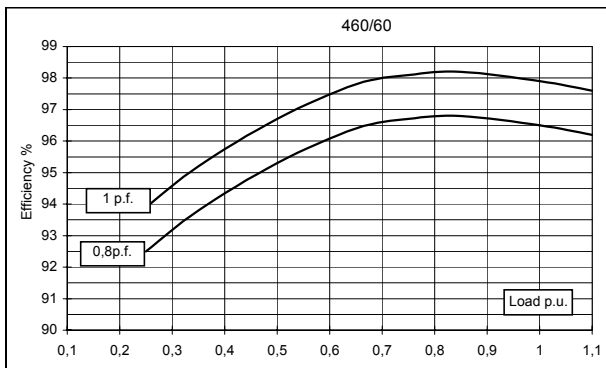
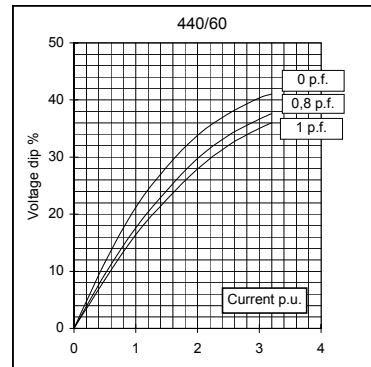
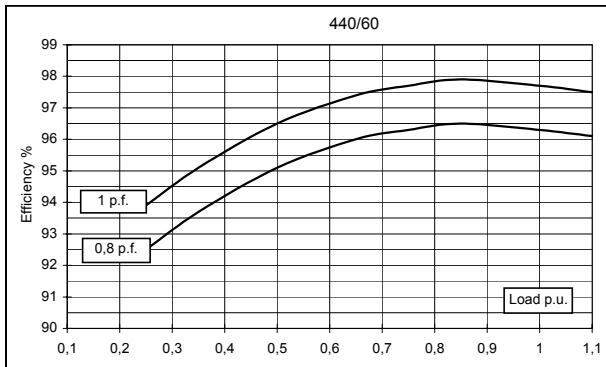
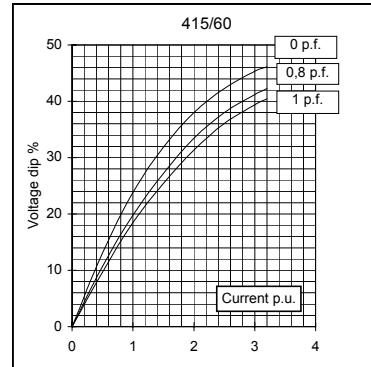
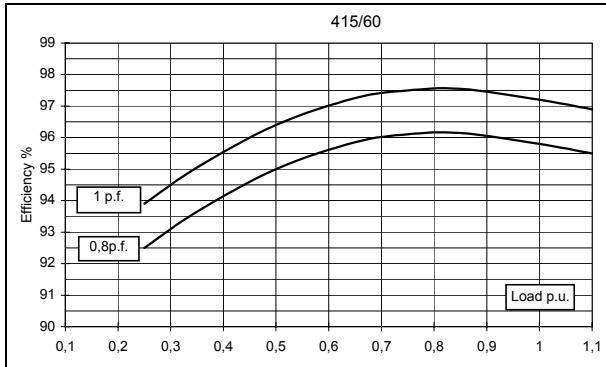

### TWO BEARING MOMENTS OF INERTIA

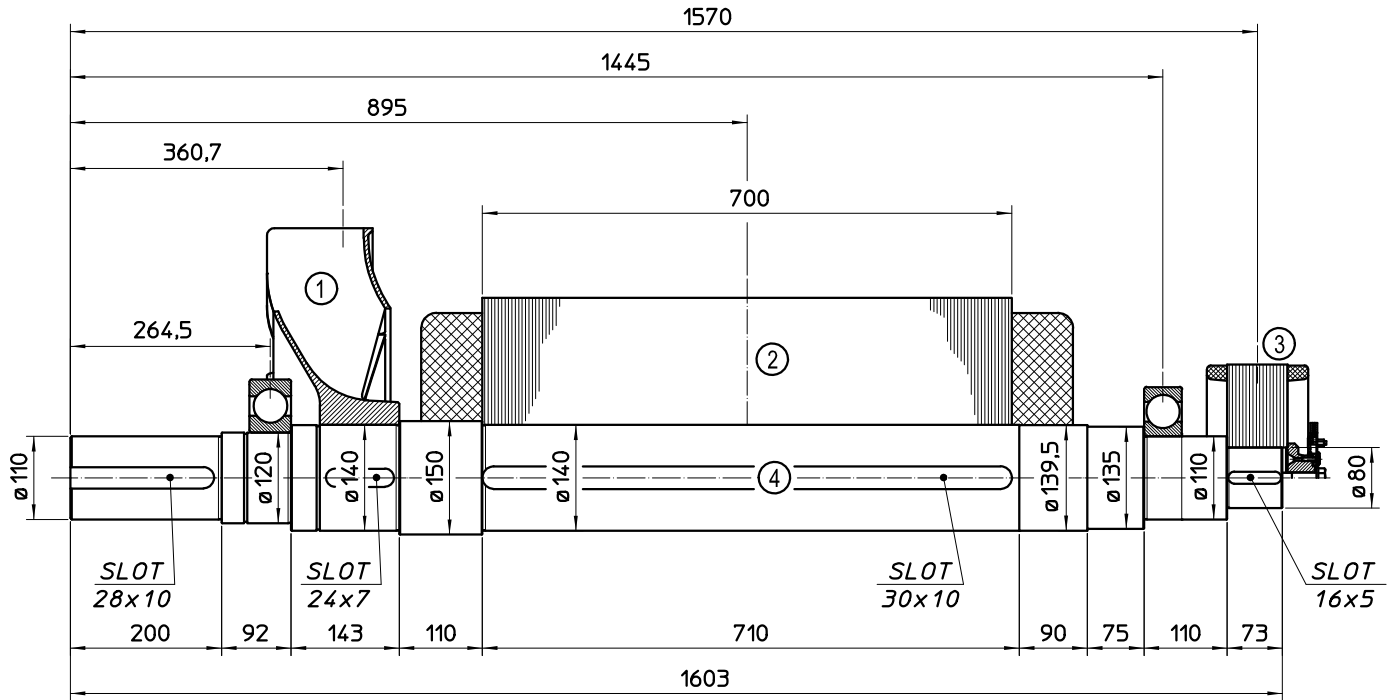

POS.	COMPONENT	WEIGHT (kg)	J (kgm <sup>2</sup> )
1	FAN	16.3	0.646
2	MAIN ROTOR	759	23.351
3	EX. ROTOR	40	0.629
4	SHAFT	171.3	0.485
TOTAL		986.6	25.111

### TWO BEARING DIMENSIONS

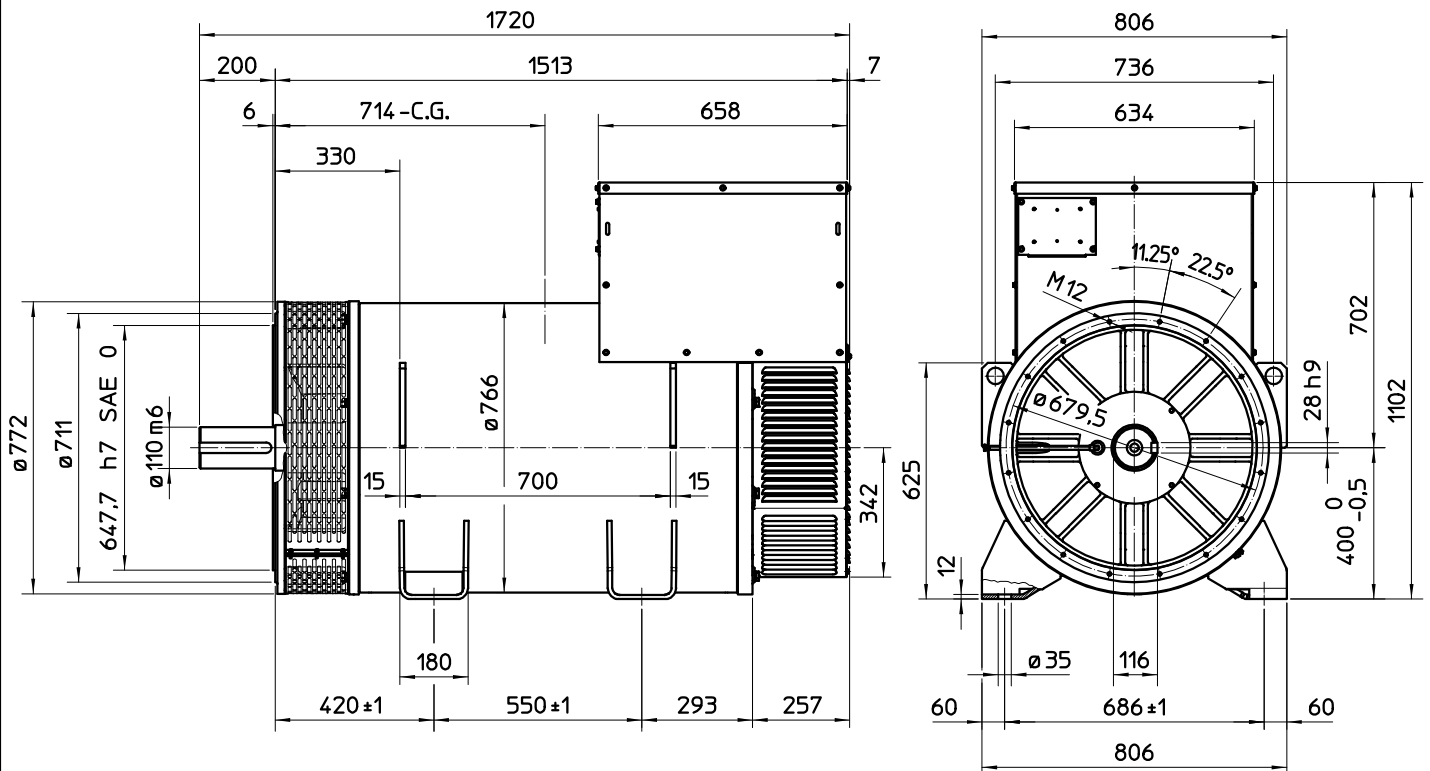

C.G.= GRAVITY CENTER

### SINGLE BEARING MOMENTS OF INERTIA

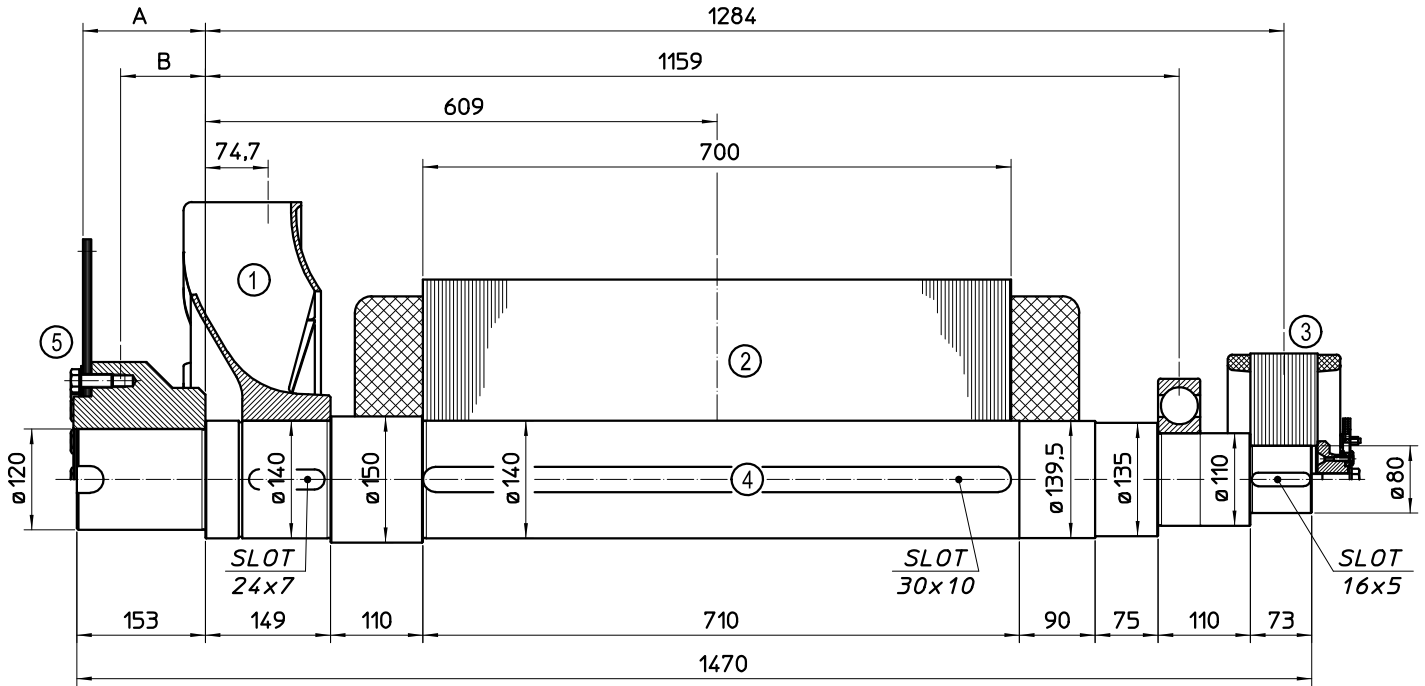

POS.	COMPONENT	WEIGHT (kg)	J (kgm <sup>2</sup> )
1	FAN	16.3	0.646
2	MAIN ROTOR	759	23.351
3	EX. ROTOR	40	0.629
4	SHAFT	159.6	0.371
TOTAL		974.9	24.997

POS.	COMPONENT	SAE N°	A	B	WEIGHT (kg)	J (kgm <sup>2</sup> )
5	SHAFTS COUPLING FLEX PLATE	14	155.7	99.5	56.3	0.824
		18	145.7	100.7	60.8	1.244
		21	130	98.5	68.9	2.231

### SINGLE BEARING DIMENSIONS

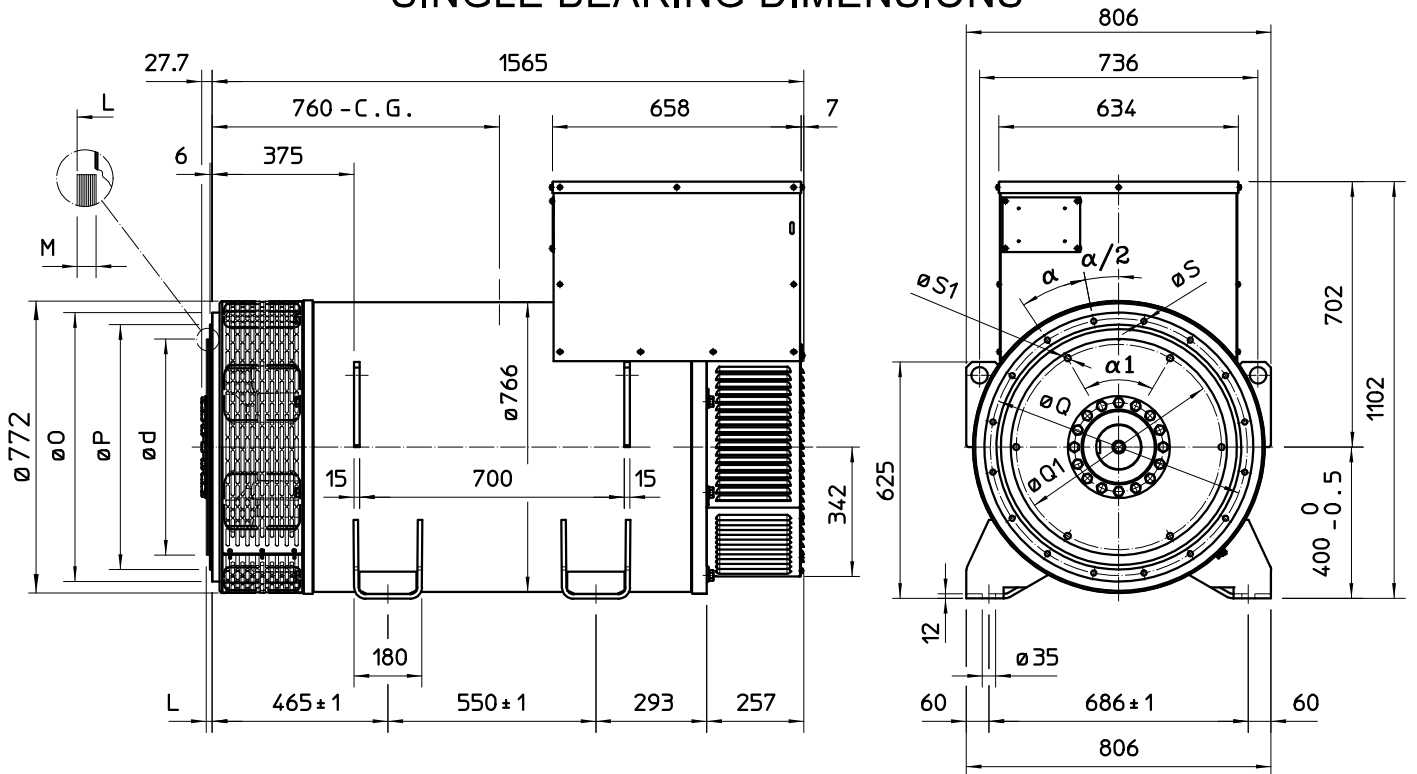

SAE N°	FLANGE					
	O	P	Q	S	HOLES N°	α
1	711	511.2	530.2	12	12	30
0	711	647.7	679.5	14	16	22.5
00	883	787.4	850.9	14	16	22.5

SAE N°	DISC COUPLING						
	d	L	M	Q1	S1	HOLES N°	α1
14	466.72	25.4	10	438.15	13.5	8	45
18	571.5	15.7	10	542.92	16.5	6	60°
21	673.1	0	12	641.35	16.5	12	30°

C.G.= GRAVITY CENTER