

Electrical Characteristics										
Frequency	Hz	50				60				
Voltage (parallel star)	V	380	400	415	440	415	440	460	480	
Rated power class H	kVA	1400	1400	1330	/	1600	1700	1700	1700	
	kW	1120	1120	1064	/	1280	1360	1360	1360	
Rated power class F	kVA	1280	1280	1210	/	1450	1540	1540	1540	
	kW	1024	1024	968	/	1160	1232	1232	1232	
Regulation with	DSR	±1% with any power factor and speed variations between -5% +30%								
Insulation class		H								
Execution		Brushless								
Stator winding		12 ends								
Rotor		with damping cage								
Efficiencies class H	4/4	%	96,3	96,2	96	95,8	96	96,5	96,7	96,6
(see graph. for details)	3/4	%	96,7	96,4	96,4	96,3	96,3	96,5	96,9	96,7
	2/4	%	95,4	95,3	95,2	94,9	95,2	95,3	95,5	95,4
	1/4	%	92,1	92,1	91,9	91,4	92,4	92,4	92,4	92,4
Reactances (f. l.c.l. F)										
	Xd	%	382,8	345,5	303,4	/	435,2	411,2	376,2	345,5
	Xd'	%	19,4	17,5	15,4	/	22,0	20,8	19,05	17,5
	Xd''	%	9,1	8,2	7,2	/	10,3	9,8	8,93	8,2
	Xq	%	128,2	115,7	101,6	/	145,7	137,7	126,0	115,7
	Xq'	%	128,2	115,7	101,6	/	145,7	137,7	126,0	115,7
	Xq''	%	20,4	18,4	16,2	/	23,2	21,9	20,0	18,4
	X ₂	%	12,7	11,5	10,1	/	14,5	13,7	12,5	11,5
	X ₀	%	4,0	3,6	3,2	/	4,5	4,3	3,92	3,6
Short Circuit Ratio	Kcc		0,26	0,29	0,33	/	0,23	0,24	0,27	0,29
Time Constants	Td'	sec.	0,31							
	Td''	sec.	0,022							
	Tdo'	sec.	9,50							
	Tα	sec.	0,032							
Short Circuit Current Capacity		%	> 300				> 300			
Excitation at no load	Amp.		1,3	1,5	1,8	/	0,9	1,0	1,2	1,4
Excitation at full load	Amp.		4,1	4,2	4,6	/	3,7	3,8	4	4,1
Overload (long-term)		%	1 hour in a 6 hours period 110% rated load							
Overload per 20 sec.		%	300							
Stator Winding Resistance (20°C)	Ω		0,0046							
Rotor Winding Resistance (20°C)	Ω		2,886							
Exciter Resistance (20 °C)	Ω		Rotor : 0,130				Stator : 10,63			
Heat dissipation at f.l.c.l.H	W		43032	44241	44333	/	53333	49326	46412	47867
Telephone Interference			THF < 2%				TIF < 40			
Radio interference			EN61000-6-3, EN61000-6-1. For others standards apply to factory							
Waveform Distors.(THD) at f. load	LL/LN %		1,7 / 1,6							
Waveform Distors.(THD) at no load	LL/LN %		2,6 / 2,5							
Mechanical characteristics										
Protection			IP 21 (other protection on request)							
DE bearing			6324							
NDE bearing			6322							
Weight of wound stator assembly	kg		1100							
Weight of wound rotor assembly	kg		1087,3							
Weight of complete generator	kg		2950							
Maximun overspeed	rpm		2250							
Unbalanced magnetic pull at f.l.c.l.F	kN/mm		6,1							
Cooling air requirement	m ³ /min		90				108			
Inertia Constant (H)	sec.		0,26				0,31			
Noise level at 1m/7m	dB(A)		95 / 84				99 / 89			

All technical data are to be considered as a reference and they can be modified without any notice.

This document is a propriety of Mecc Alte S.p.A.. All rights reserved.

50 Hz

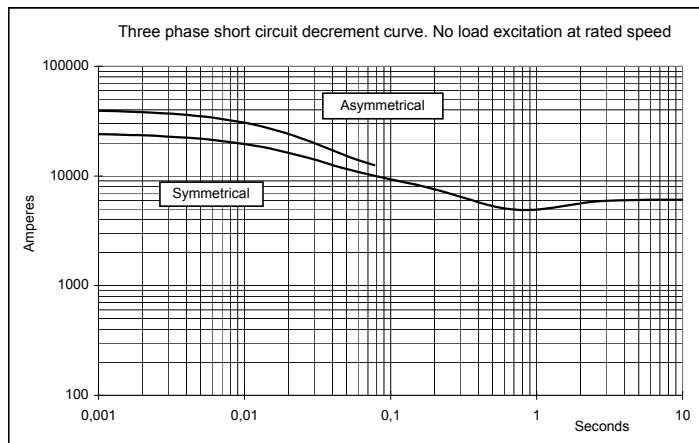
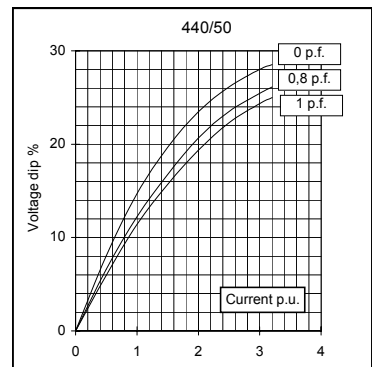
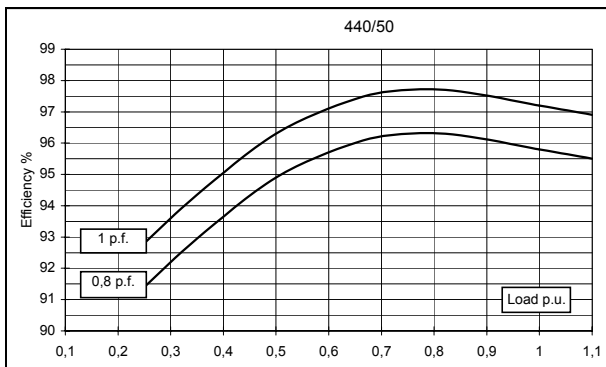
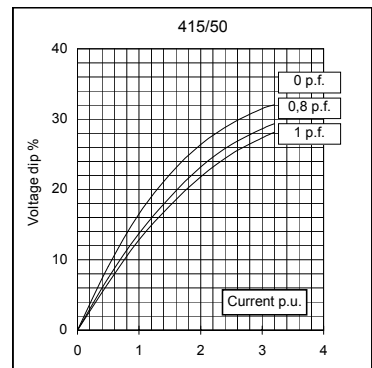
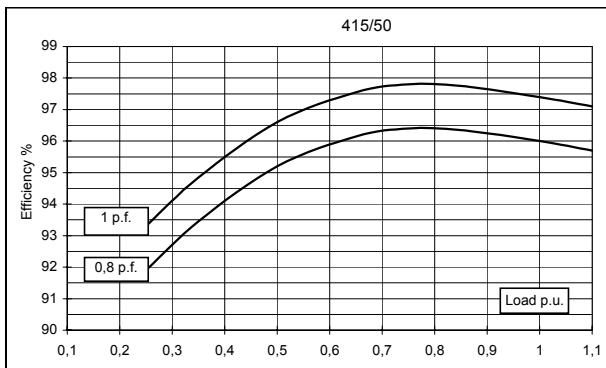
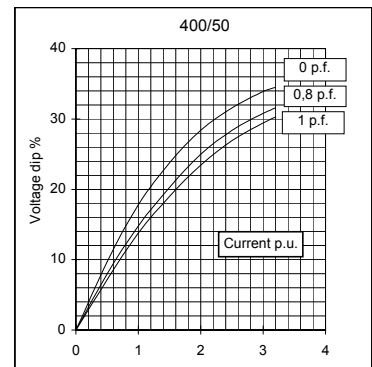
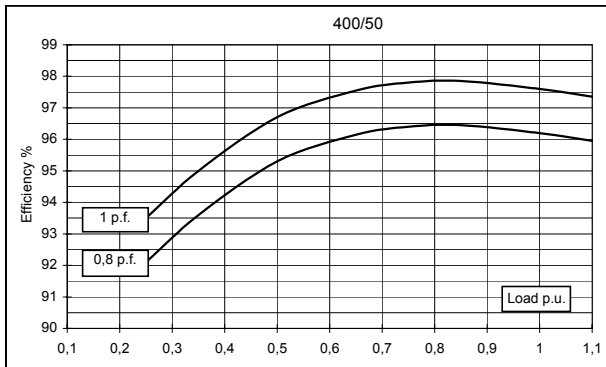
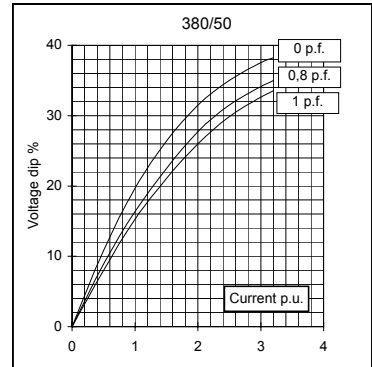
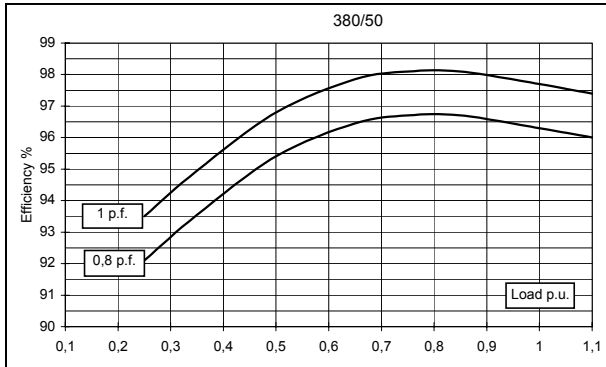

60 Hz

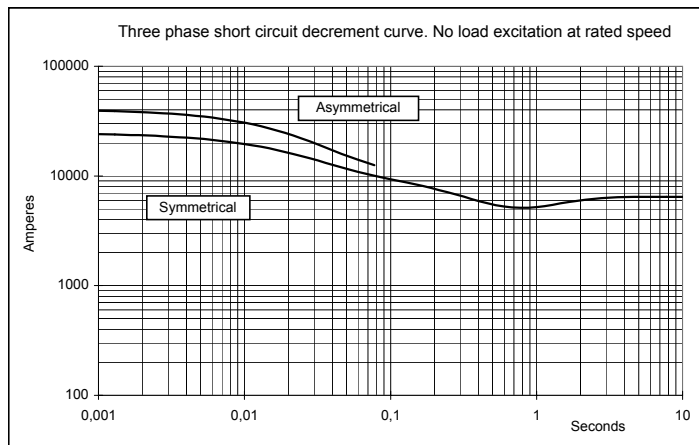
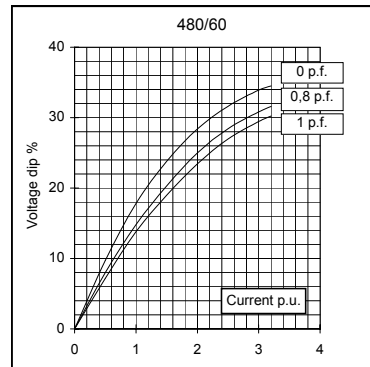
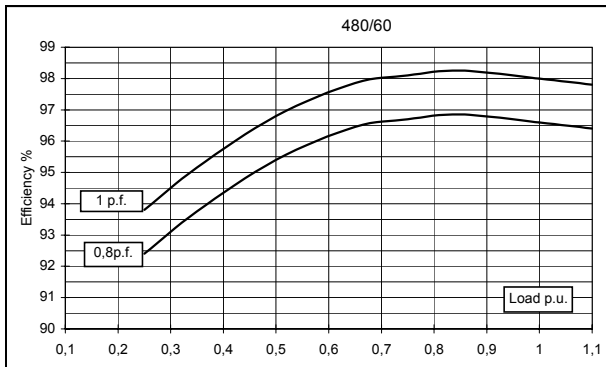
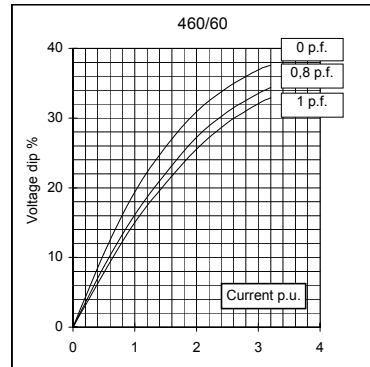
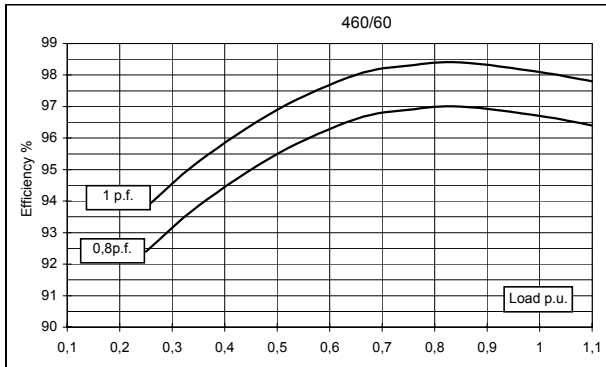
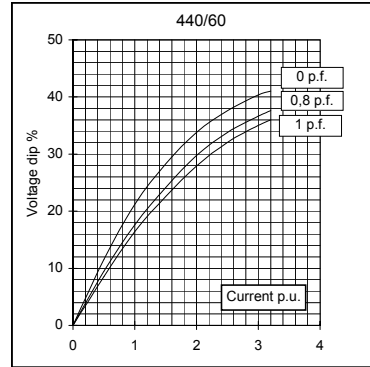
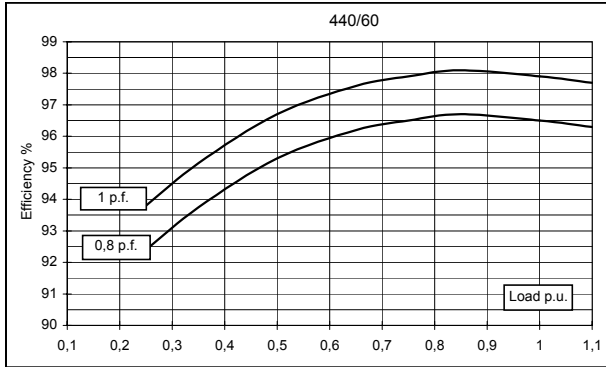
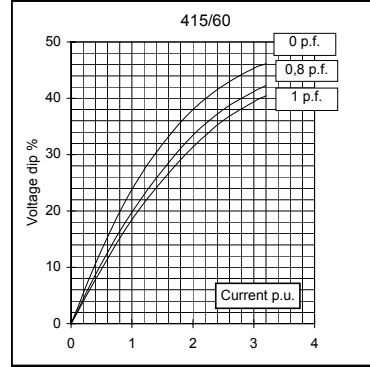
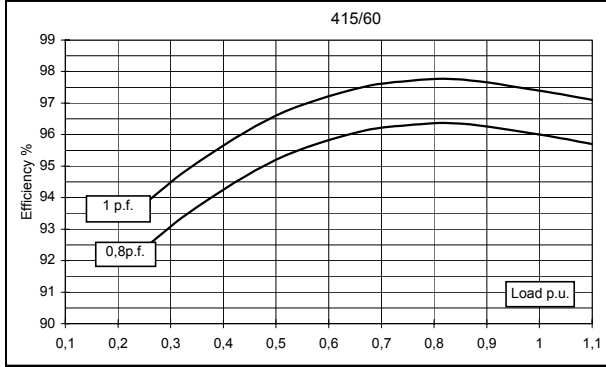

TWO BEARING MOMENTS OF INERTIA

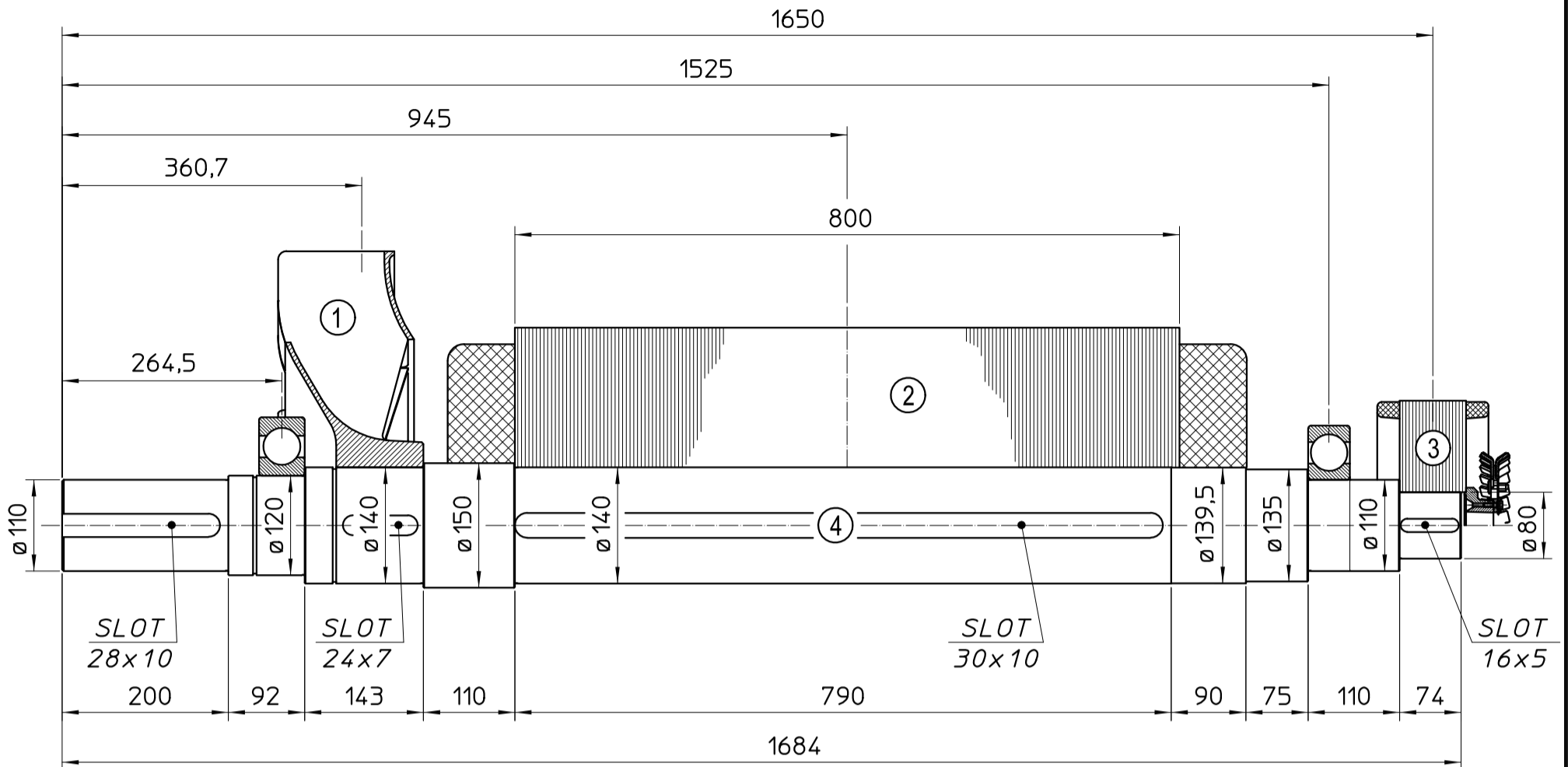

POS.	COMPONENT	WEIGHT (kg)	J (kgm ²)
1	FAN	16.3	0.646
2	MAIN ROTOR	854	24,560
3	EX. ROTOR	40	0,491
4	SHAFT	177	0,404
TOTAL		1087,3	26,101

TWO BEARING DIMENSIONS

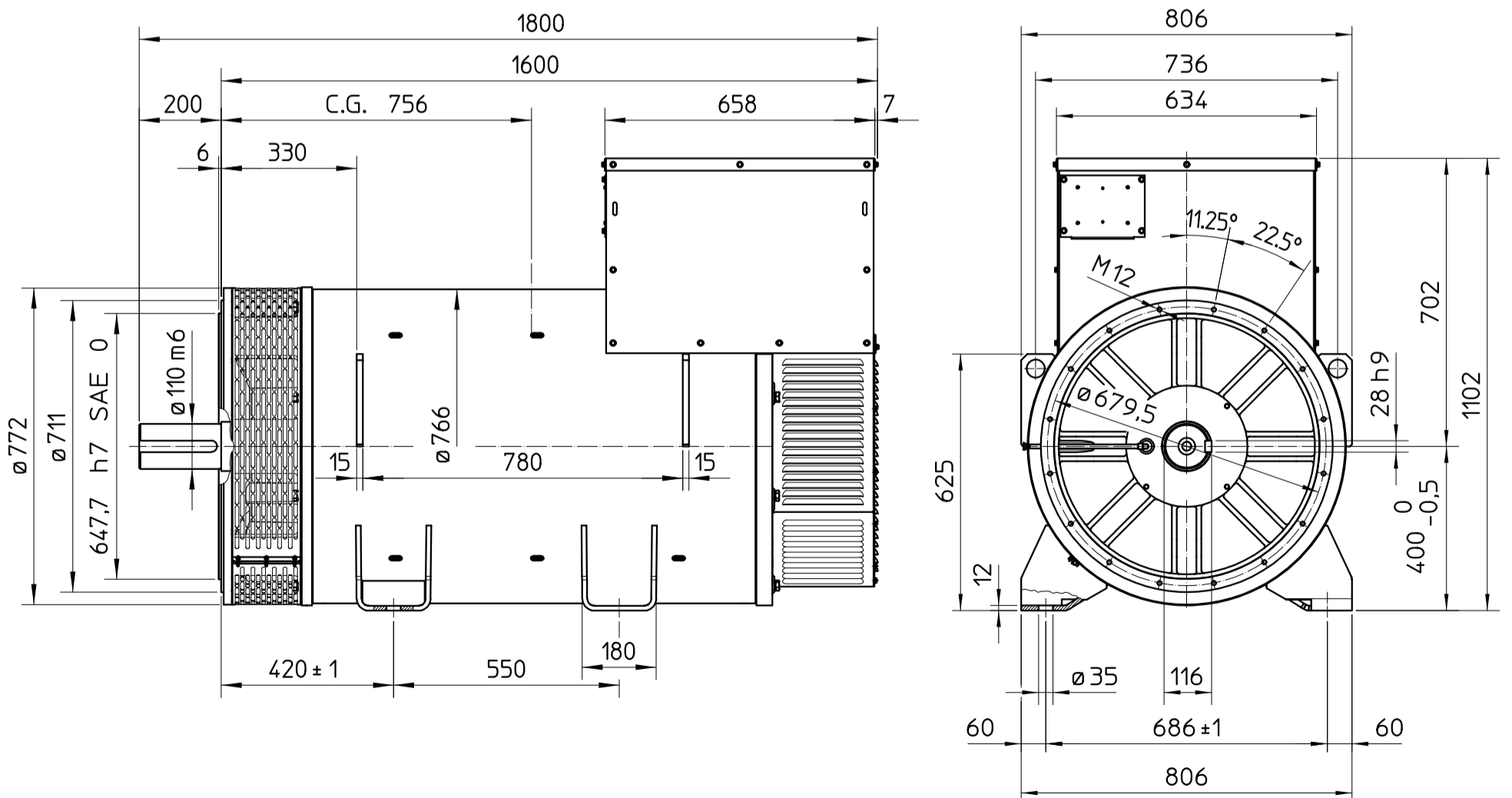

C.G.= GRAVITY CENTER

SINGLE BEARING MOMENTS OF INERTIA

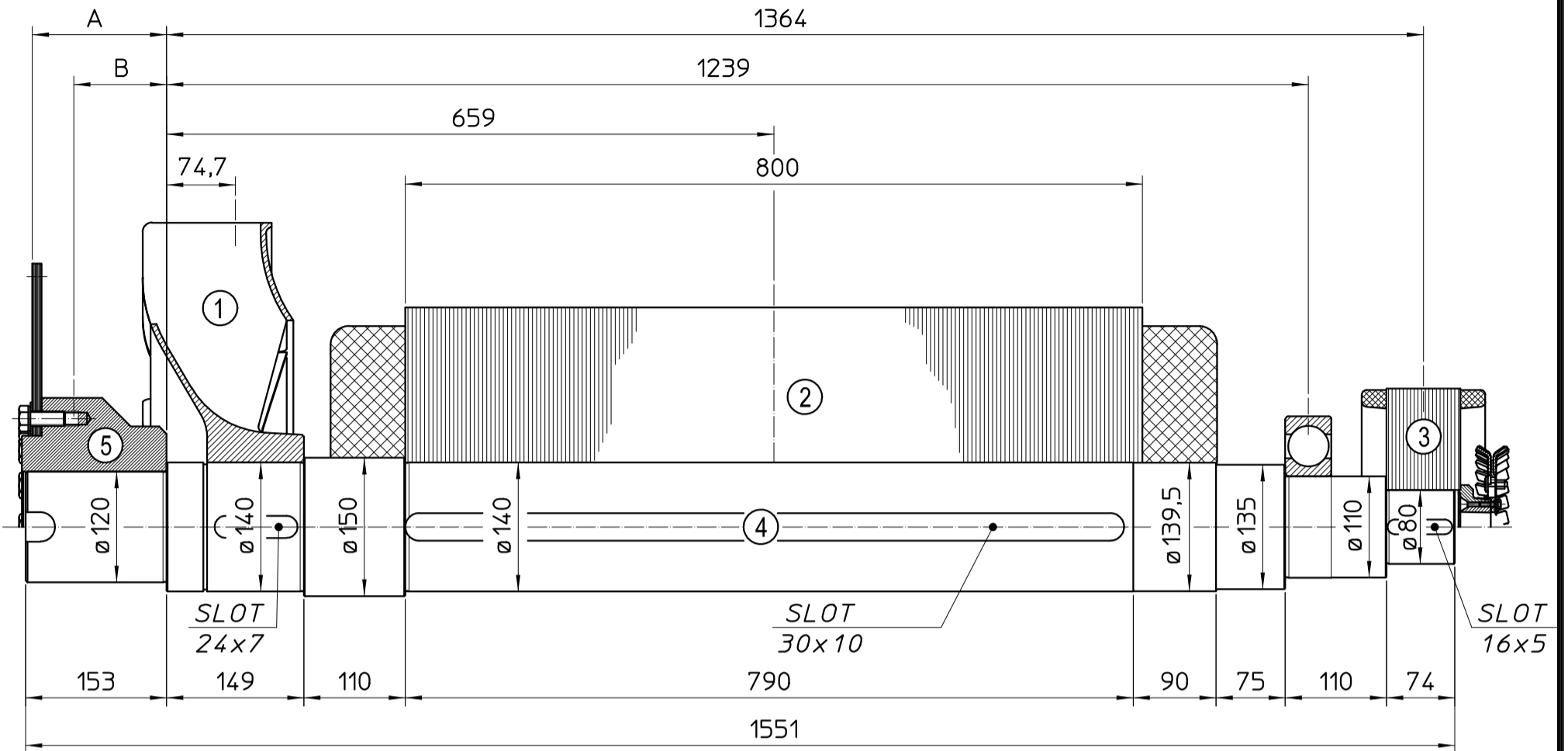

POS.	COMPONENT	WEIGHT (kg)	J (kgm ²)
1	FAN	16.3	0.646
2	MAIN ROTOR	854	24,560
3	EX. ROTOR	40	0,491
4	SHAFT	169	0.393
TOTAL		1079,3	26.090

SAE N°	SHAFTS COUPLING FLEX PLATE			
	A	B	WEIGHT kg	J kgm ²
14	155.7	99.5	56.3	0.824
18	145.7	100.7	60.8	1.244
21	130	98.5	68.9	2.231

SINGLE BEARING DIMENSIONS

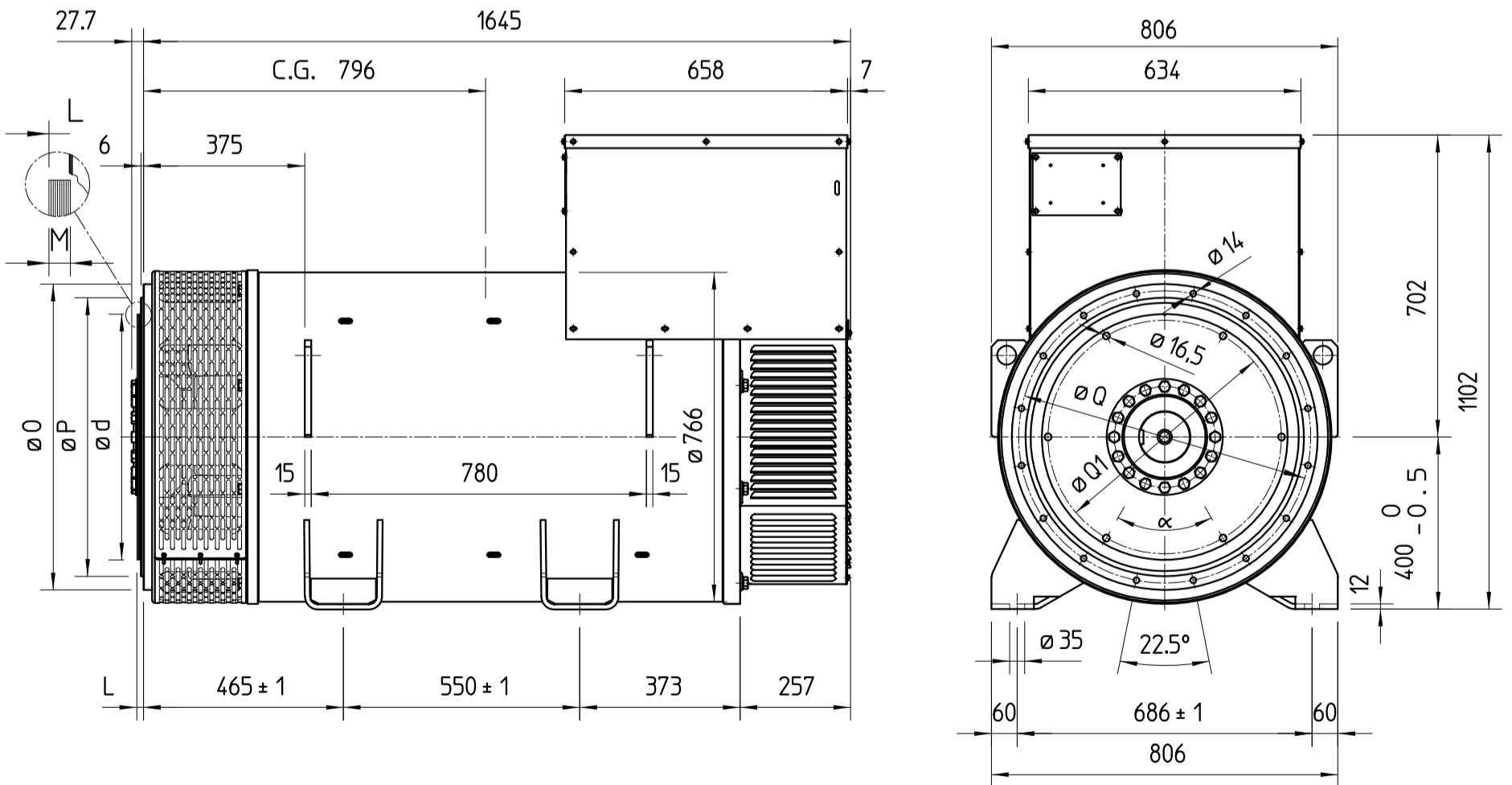

SAE N°	FLANGE					
	O	P	Q	S	HOLES N°	α
1	711	511.2	530.2	12	12	30
0	711	647.7	679.5	14	16	22.5
00	883	787.4	850.9	14	16	22.5

SAE N°	DISC COUPLING						
	d	L	M	Q1	S1	HOLES N°	α1
14	466.72	25.4	10	438.15	13.5	8	45
18	571.5	15.7	10	542.92	16.5	6	60°
21	673.1	0	12	641.35	16.5	12	30°

C.G.= GRAVITY CENTER