



GENERATOR TYPE ECP 28-2L/4 A

Document : **DS280A/1**
issue 001 date 14/10/2013

Electrical Characteristics										
Frequency	Hz	50				60				
Voltage (series star)	V	380	400	415	440	415	440	460	480	
Rated power class H	kVA	25	25	25	-	26	27,5	30	30	
	kW	20	20	20	-	20,8	22	24	24	
Rated power class F	kVA	23	23	23	-	24	25,5	27,5	27,5	
	kW	18,4	18,4	18,4	-	19,2	20,4	22	22	
Regulation with	DSR	±1 % with any power factor and speed variations between -5% +30%								
Insulation class		H								
Execution		Brushless								
Stator winding		12 ends								
Rotor		with damping cage								
Efficiencies class H	4/4	%	87,4	87,8	88,1	-	88,8	89,1	89,3	89,7
(see graph. for details)	3/4	%	87,8	88,1	88,2	-	89,4	89,6	89,8	90
	2/4	%	86	86,1	86,1	-	87,7	87,8	87,9	88
	1/4	%	83,8	83,6	83,6	-	85,9	85,7	85,9	85,8
Reactances (f. l.cl. F)	Xd	%	205,0	185	171,9	-	214,5	201,8	201,4	185
	Xd'	%	17,95	16,2	15,05	-	18,78	17,67	17,64	16,2
	Xd''	%	10,19	9,2	8,55	-	10,67	10,04	10,02	9,2
	Xq	%	84,2	76	70,6	-	88,1	82,9	82,8	76
	Xq'	%	84,2	76	70,6	-	88,1	82,9	82,8	76
	Xq''	%	23,3	21	19,5	-	24,3	22,9	22,9	21
	X ₂	%	15,18	13,7	12,73	-	15,88	14,95	14,92	13,7
	X ₀	%	3,43	3,1	2,88	-	3,59	3,38	3,38	3,1
Short Circuit Ratio	Kcc		0,50	0,58	0,80	-	0,38	0,43	0,50	0,58
Time Constants	Td'	sec.	0,047							
	Td''	sec.	0,013							
	Tdo'	sec.	0,93							
	Tα	sec.	0,011							
Short Circuit Current Capacity		%	>300				>350			
Excitation at no load	Amp.		0,45	0,6	0,7	-	0,3	0,4	0,5	0,55
Excitation at full load	Amp.		1,4	1,6	1,8	-	1,3	1,4	1,5	1,6
Overload (long-term)	%	1 hour in a 6 hours period 110% rated load								
Overload per 20 sec.	%	300								
Stator Winding Resistance (20 °C)	Ω	0,128								
Rotor Winding Resistance (20 °C)	Ω	1,67								
Exciter Resistance (20 °C)	Ω	Rotor : 0,417				Stator : 10,60				
Heat dissipation at f.l.cl.H	W	2883	2779	2701	-	2623	2691	2876	2756	
Telephone Interference		THF < 2%				TIF < 45				
Radio interference		EN61000-6-3 EN61000-6-1. For others standards apply to factory								
Waveform Distors.(THD) at f. load	LL/LN %	2 / 2								
Waveform Distors.(THD) at no load	LL/LN %	3,4 / 3,2								
Mechanical characteristics										
Protection		IP 23 (other protection on request)								
DE bearing		6309-2RS								
NDE bearing		6207-2RS								
Weight of wound stator assembly	kg	50								
Weight of wound rotor assembly	kg	28,1								
Weight of complete generator	kg	136								
Maximun overspeed	rpm	2250								
Unbalanced magnetic pull at f.l.cl.F	kN/mm	4,5								
Cooling air requirement	m³/min	5,3				5,8				
Inertia Constant (H)	sec.	0,070				0,084				
Noise level at 1m/7m	dB(A)	68 / 57				71 / 61				

All technical data are to be considered as a reference and they can be modified without any notice
This document is a propriety of Mecc Alte S.p.a..All rights reserved.



GENERATOR TYPE ECP 28-2L/4 A

Document : DS280A/2

issue 001 date : 14/10/2013

50 Hz

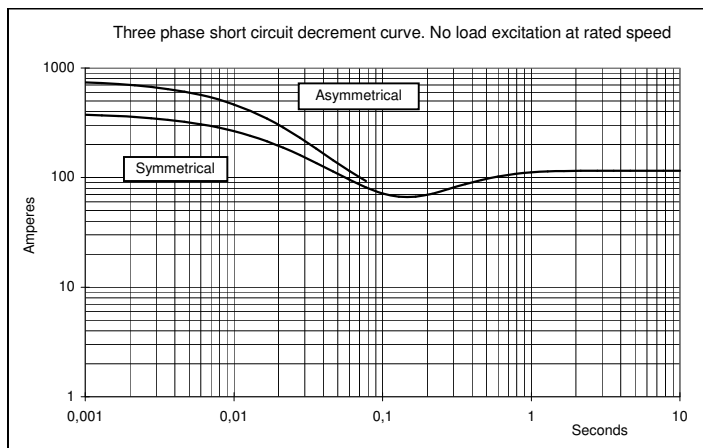
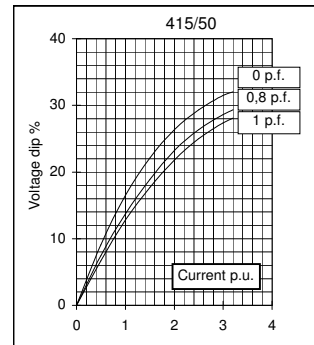
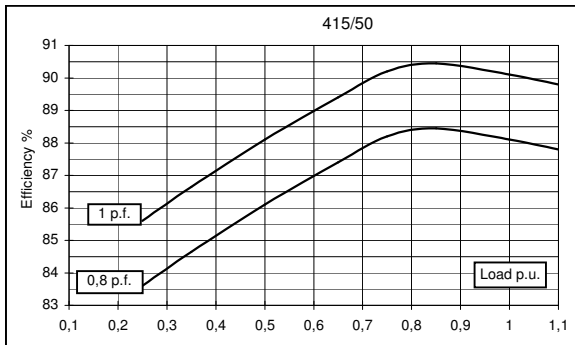
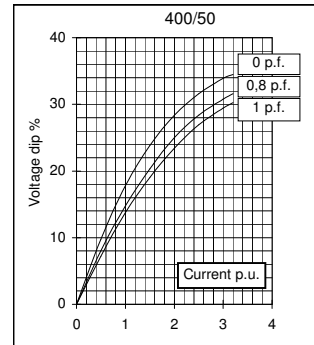
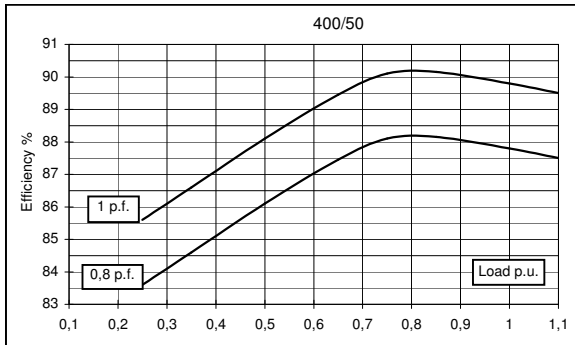
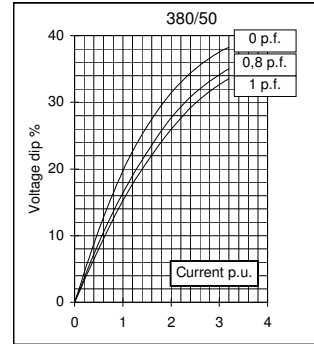
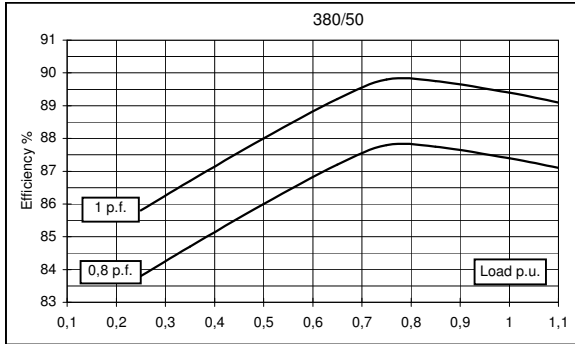

60 Hz

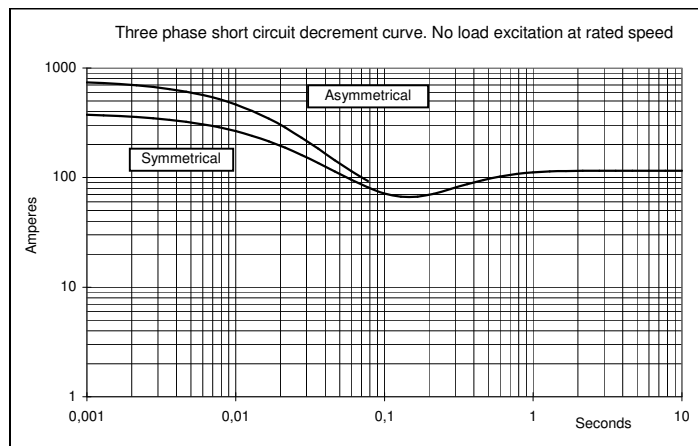
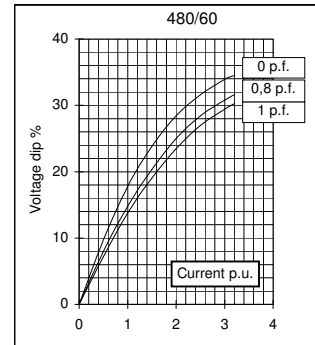
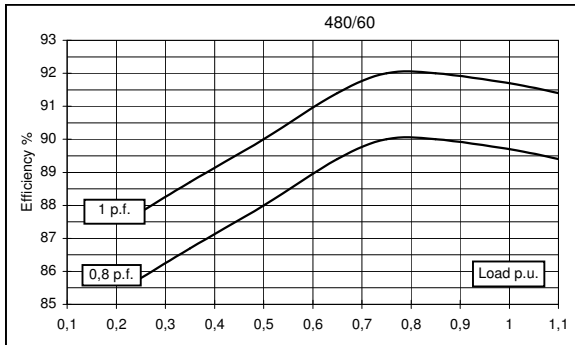
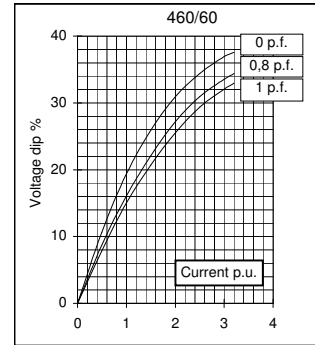
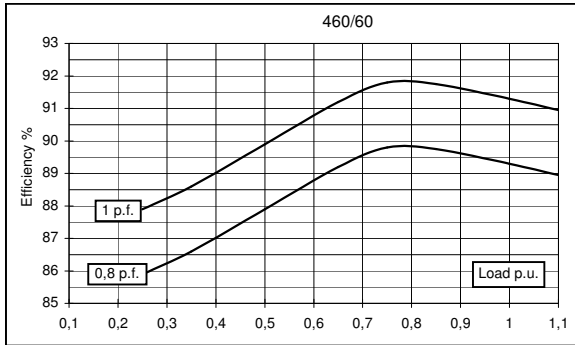
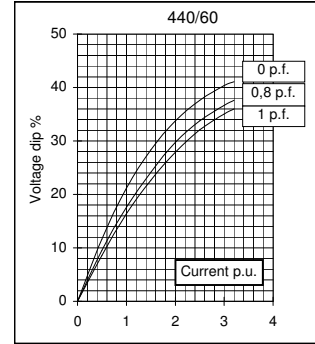
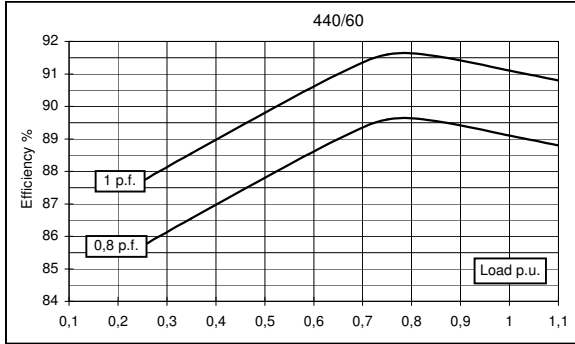
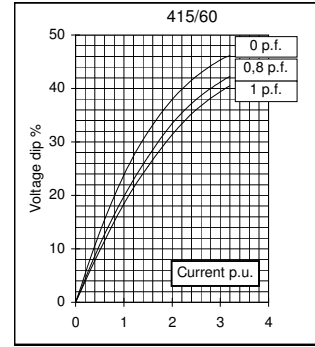
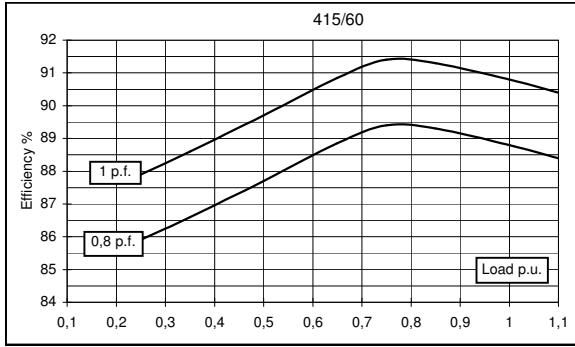

TWO BEARING MOMENTS OF INERTIA

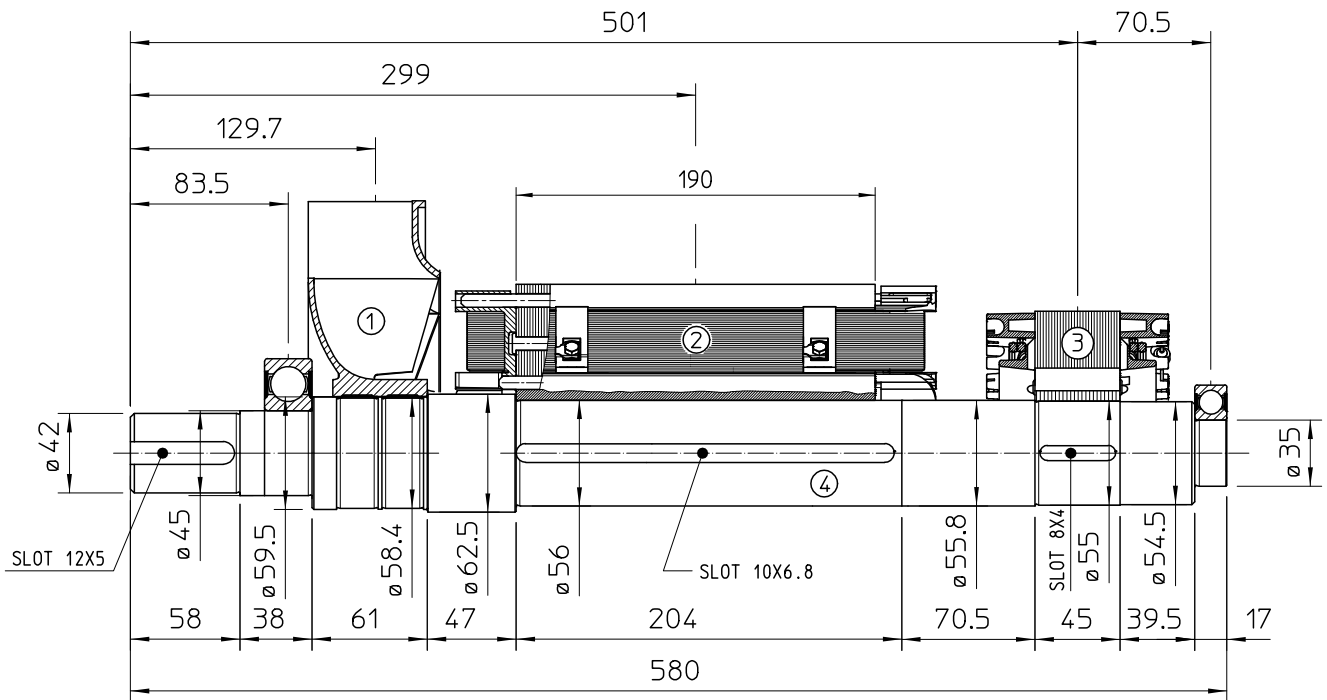

POS.	COMPONENT	WEIGHT (kg)	J (kgm ²)
1	FAN	1.2	0.0087
2	MAIN ROTOR	28.1	0.1121
3	EX. ROTOR	5.5	0.0172
4	SHAFT	10.2	0.0041
TOTAL		45	0.1421

TWO BEARING DIMENSIONS

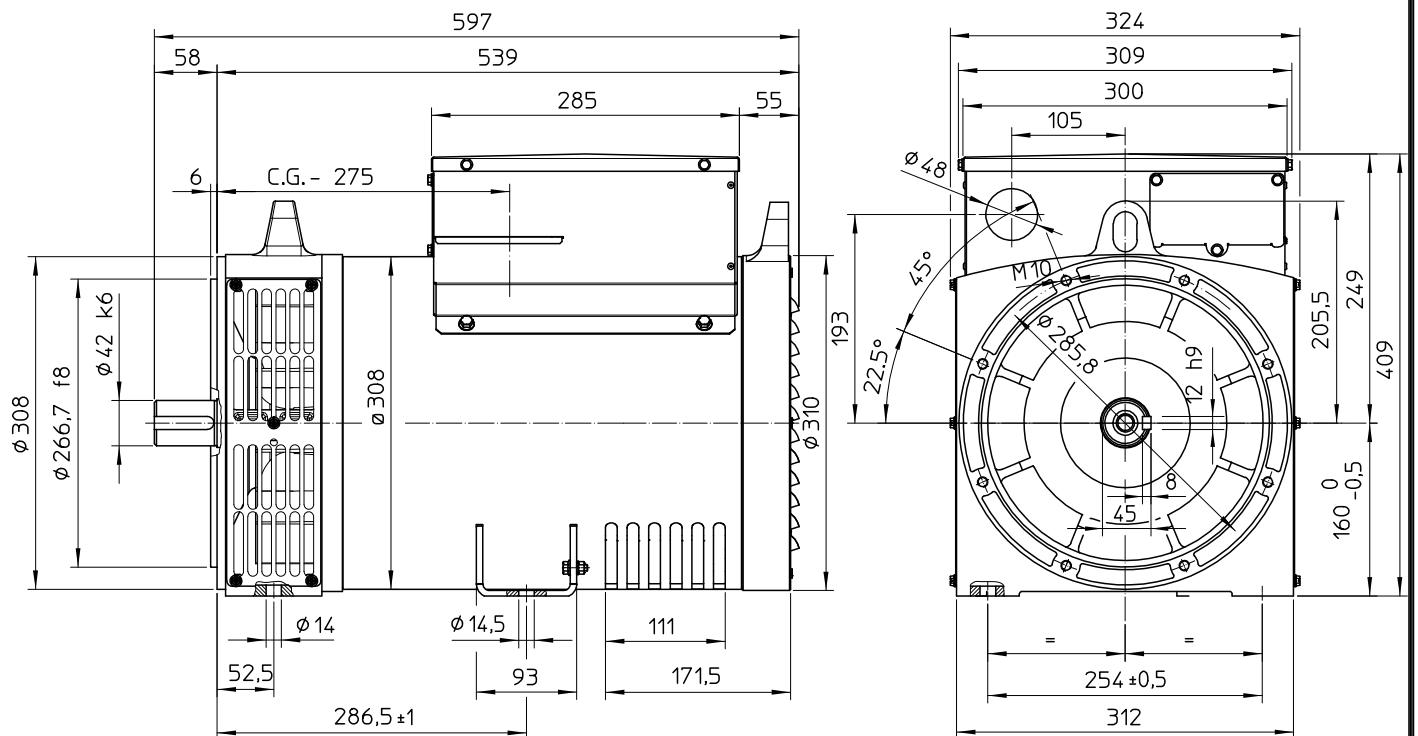

C.G.= GRAVITY CENTER

SINGLE BEARING MOMENTS OF INERTIA

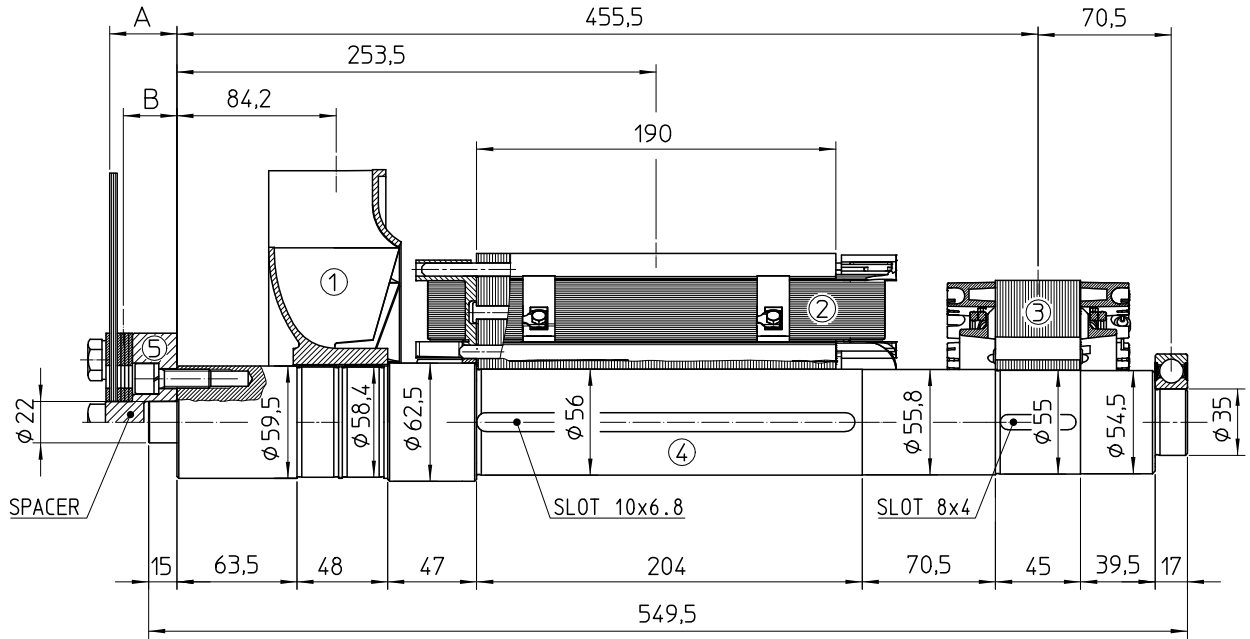

POS.	COMPONENT	WEIGHT (kg)	J (kgm ²)
1	FAN	1.2	0.0087
2	MAIN ROTOR	28.1	0.1121
3	EX. ROTOR	5.5	0.0172
4	SHAFT	10.2	0.0041
TOTAL		45	0.1421

SAE N°	5		SHAFTS COUPLING FLEX PLATE	
	A	B	WEIGHT kg	J kgm ²
6 1/2	4	2	1.08	0.0065
7 1/2	4	2	1.35	0.0101
8	35.6	28.3	2.84	0.0158
10	27.6	22.9	3.25	0.0303
11 1/2	14	11.2	3.6	0.0471

SINGLE BEARING DIMENSIONS

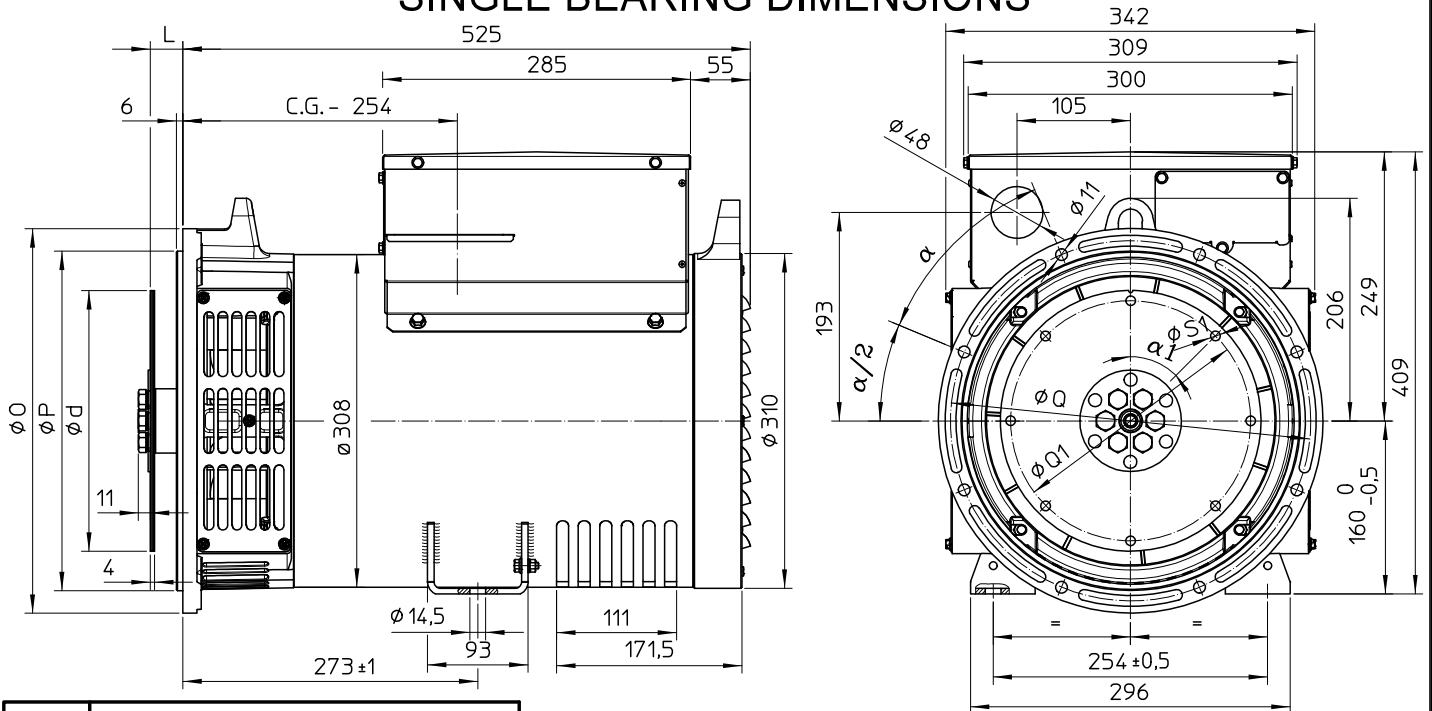

SAE N.	GIUNTI A DISCHI / DISC COUPLING DISCQUE DE MONOPALIER / SCHEIBENKUPPLUNG				
	d	L	Q1	S1	α ₁
6 1/2	215.9	30.2	200	9	60°
7 1/2	241.3	30.2	222.25	9	45°
8	263.52	62	244.47	11	60°
10	314.32	53.8	295.27	11	45°
11 1/2	352.42	39.6	333.37	11	45°

SAE N.	FLANGIA / FLANGE BRIDE / FLANSCH			
	O	P	Q	α
5	356	314.3	333.4	45°
4	403	362	381	30°
3	451	409.6	428.6	30°
2	490	447.7	466.7	30°

C.G.= GRAVITY CENTER