



GENERATOR TYPE ECP 3-2L/2

Document : DS157A/1

issue 003 date 05/05/2014

Electrical Characteristics										
Frequency	Hz	50				60				
Voltage (series star)	V	380	400	415	440	415	440	460	480	
Rated power class H	kVA	20	20	20	16	21	24	24	24	
	kW	16	16	16	12,8	16,8	19,2	19,2	19,2	
Rated power class F	kVA	18	18	18	14,3	18	21,5	21,5	21,5	
	kW	14,4	14,4	14,4	11,4	14,4	17,2	17,2	17,2	
Regulation with	DSR	±1 % with any power factor and speed variations between -5% +30%								
Insulation class		H								
Execution		Brushless								
Stator winding		12 ends								
Rotor		with damping cage								
Efficiencies class H	4/4	%	85,4	85,5	85,2	85	86,5	87	87,1	87,2
(see graph. for details)	3/4	%	85,7	86	85,9	85,6	87,2	87,4	87,6	87,8
	2/4	%	82,4	82,5	82,5	82,2	84,2	84,3	84,4	84,5
	1/4	%	78,1	78	77,8	77,3	79,3	79,1	79,2	79,5
Reactances (f. l.cl. F)	Xd	%	213,9	193	179,3	127,6	225,9	229,7	210,1	193
	Xd'	%	29,5	26,6	24,7	17,6	31,1	31,7	29	26,6
	Xd''	%	16,1	14,5	13,5	9,6	17	17,3	15,8	14,5
	Xq	%	111,9	101	93,8	66,8	118,2	120,2	110	101
	Xq'	%	111,9	101	93,8	66,8	118,2	120,2	110	101
	Xq''	%	40,4	36,5	33,9	24,1	42,7	43,4	39,7	36,5
	X ₂	%	19,7	17,8	16,5	11,8	20,8	21,2	19,4	17,8
	X ₀	%	6,1	5,5	5,1	3,6	6,4	6,5	6	5,5
Short Circuit Ratio	Kcc		0,51	0,63	0,84	1,46	0,38	0,46	0,51	0,63
Time Constants	Td'	sec.	0,055							
	Td''	sec.	0,011							
	Tdo'	sec.	0,70							
	T _α	sec.	0,01							
Short Circuit Current Capacity		%	>300				>320			
Excitation at no load	Amp.		0,32	0,35	0,4	0,45	0,2	0,27	0,3	0,33
Excitation at full load	Amp.		1,2	1,27	1,3	1,4	1	1,04	1,1	1,2
Overload (long-term)		%	1 hour in a 6 hours period 110% rated load							
Overload per 20 sec.		%	300							
Stator Winding Resistance (20°C)	Ω		0,221							
Rotor Winding Resistance (20°C)	Ω		9,627							
Exciter Resistance (20 °C)	Ω		Rotor : 1,453				Stator : 15,71			
Heat dissipation at f.l.cl.H	W		2735	2713	2779	2259	2622	2869	2844	2818
Telephone Interference			THF < 2%				TIF < 45			
Radio interference			EN61000-6-3, EN61000-6-2. For others standards apply to factory							
Waveform Distors.(THD) at f. load	LL/LN %		4,7 / 4,4							
Waveform Distors.(THD) at no load	LL/LN %		3,6 / 3,4							
Mechanical characteristics										
Protection			IP 23 (other protection on request)							
DE bearing			6308-2RS							
NDE bearing			6305-2RS							
Weight of wound stator assembly	kg		27							
Weight of wound rotor assembly	kg		14							
Weight of complete generator	kg		88							
Maximun overspeed	rpm		4500							
Unbalanced magnetic pull at f.l.cl.F	kN/mm		3,1							
Cooling air requirement	m³/min		5,8				6,8			
Inertia Constant (H)	sec.		0,150				0,180			
Noise level at 1m/7m	dB(A)		85 / 70				89 / 73			

All technical data are to be considered as a reference and they can be modified without any notice.

This document is a propriety of Mecc Alte S.p.a..All rights reserved.



GENERATOR TYPE ECP 3-2L/2

Document : DS157A/2

issue 003 date : 05/05/2014

50 Hz

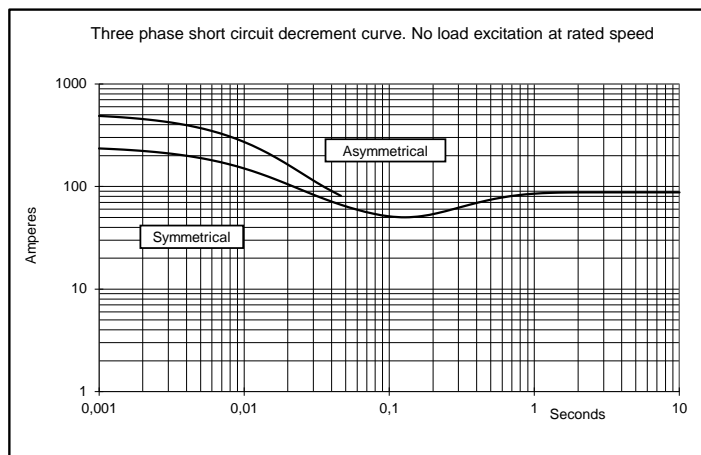
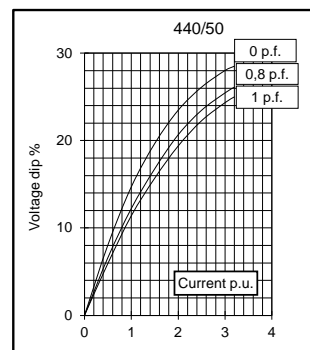
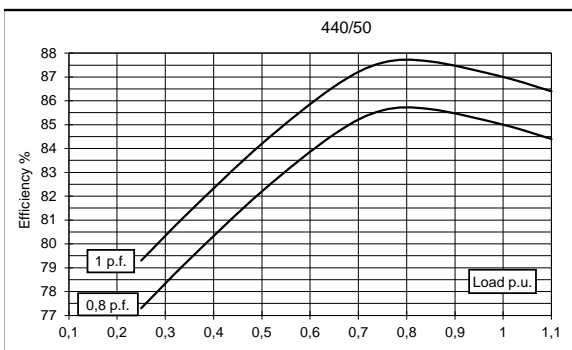
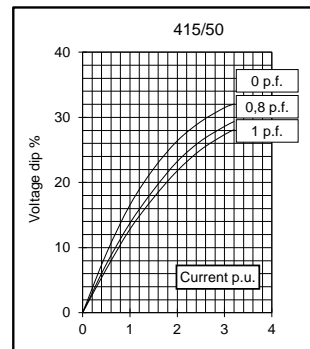
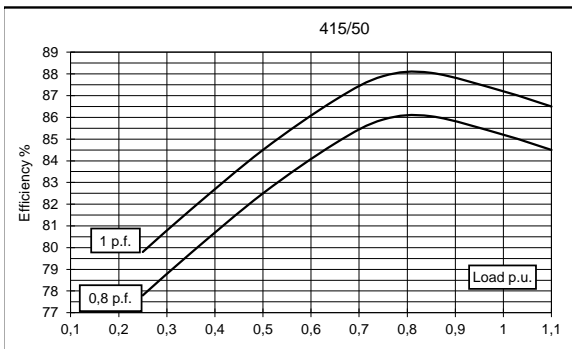
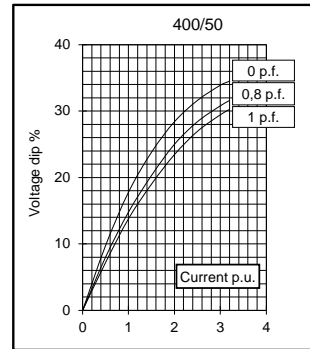
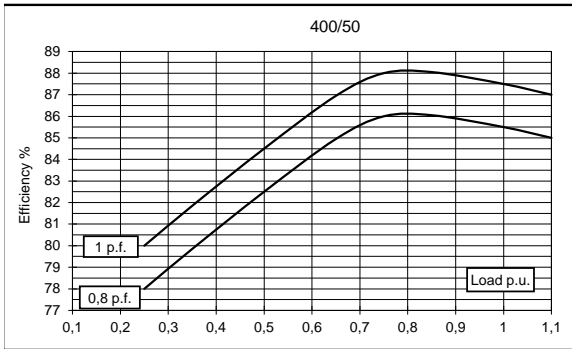
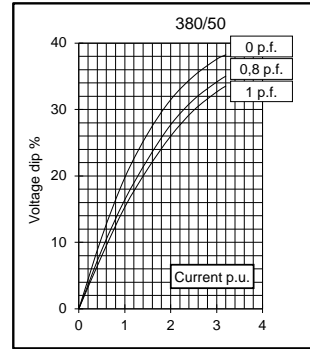
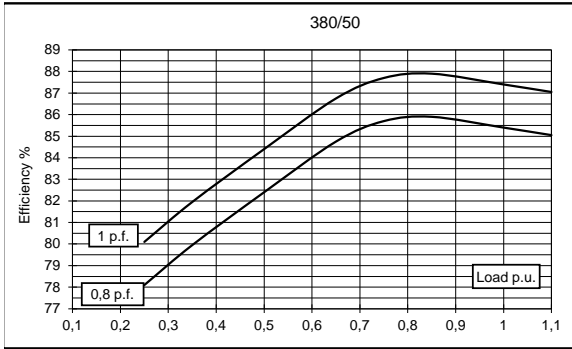

60 Hz

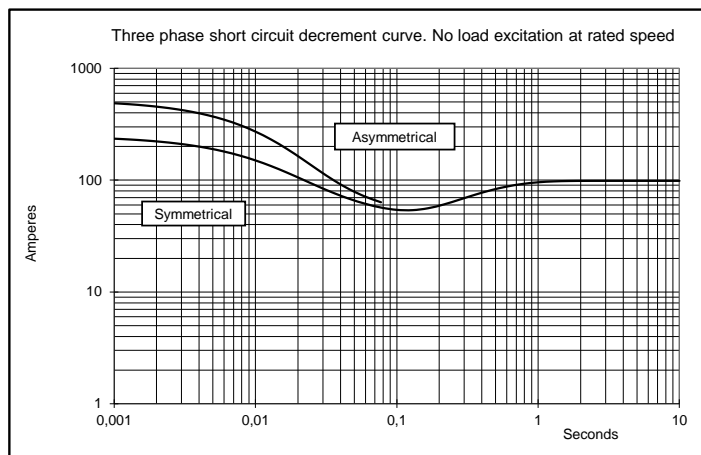
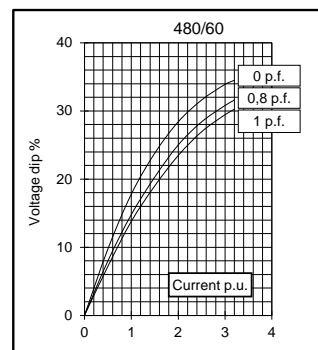
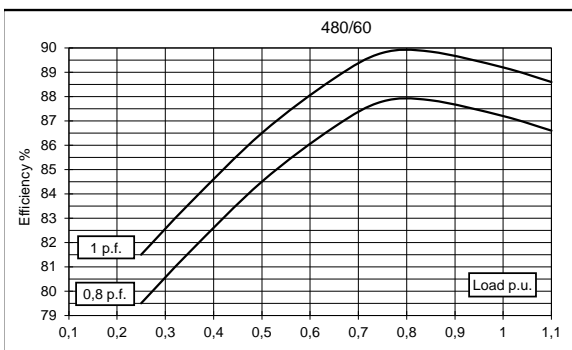
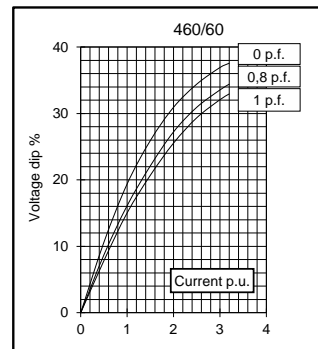
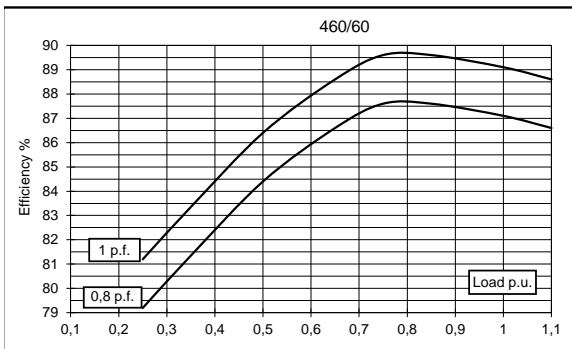
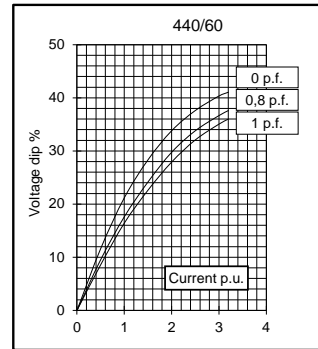
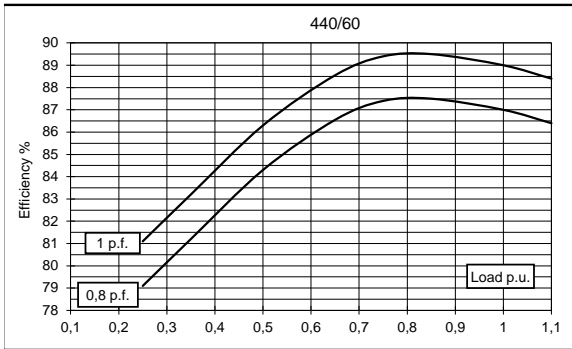
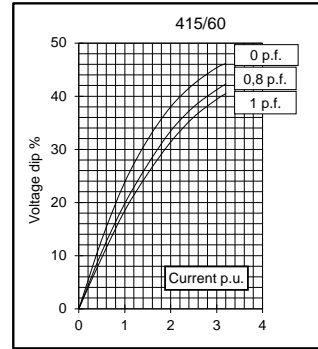
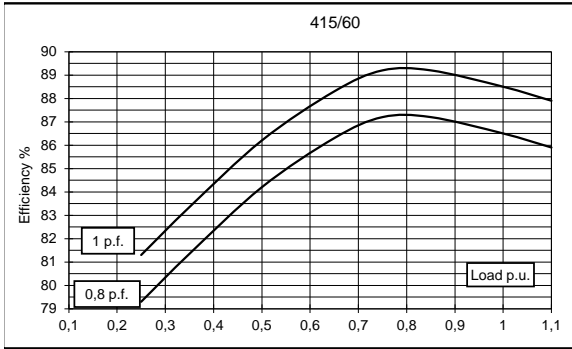

TWO BEARING MOMENTS OF INERTIA

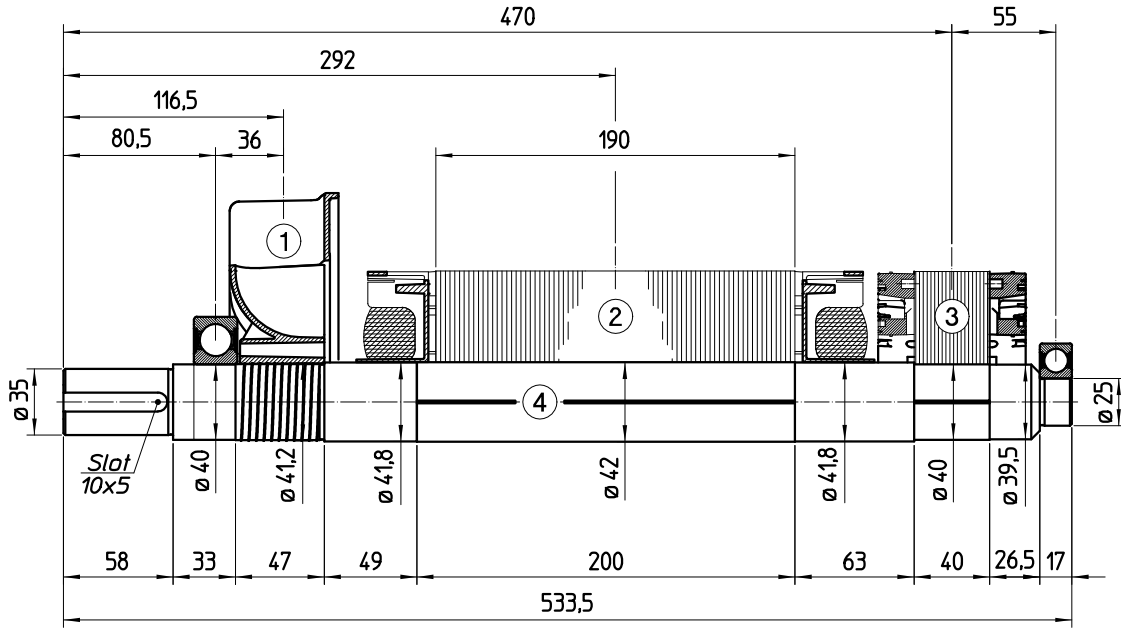

POS.	COMPONENT	WEIGHT (kg)	J (kgm ²)
1	FAN	0,4	0,00206
2	MAIN ROTOR	18,0	0,04342
3	EX. ROTOR	4,2	0,01086
4	SHAFT	5,2	0,00101
TOTAL		27,8	0,05735

TWO BEARING DIMENSIONS

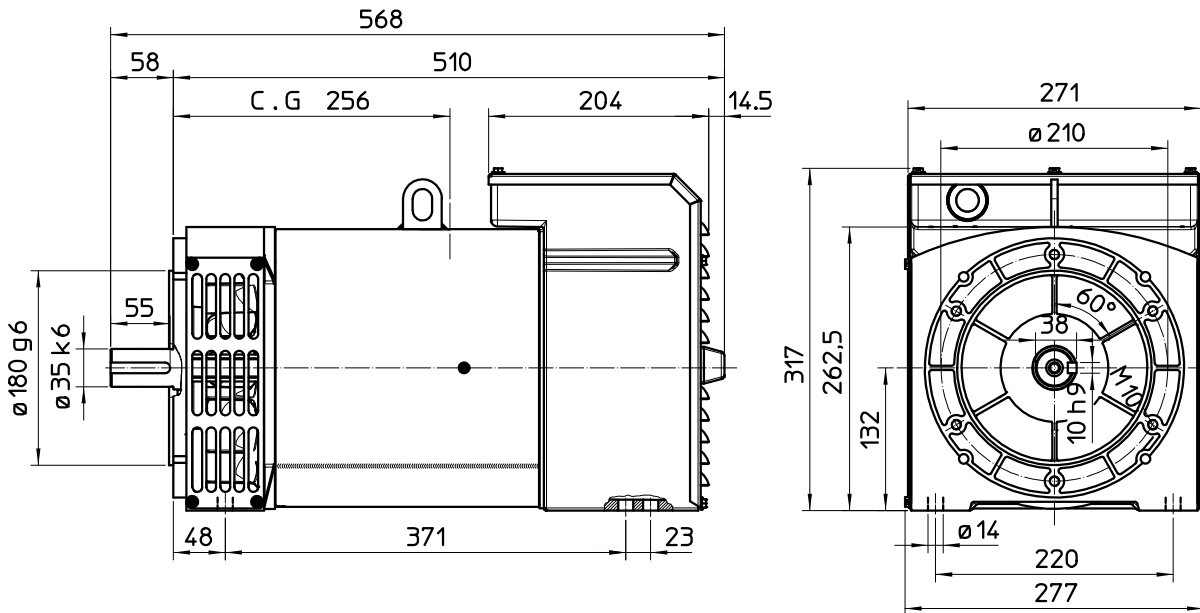

SINGLE BEARING MOMENTS OF INERTIA

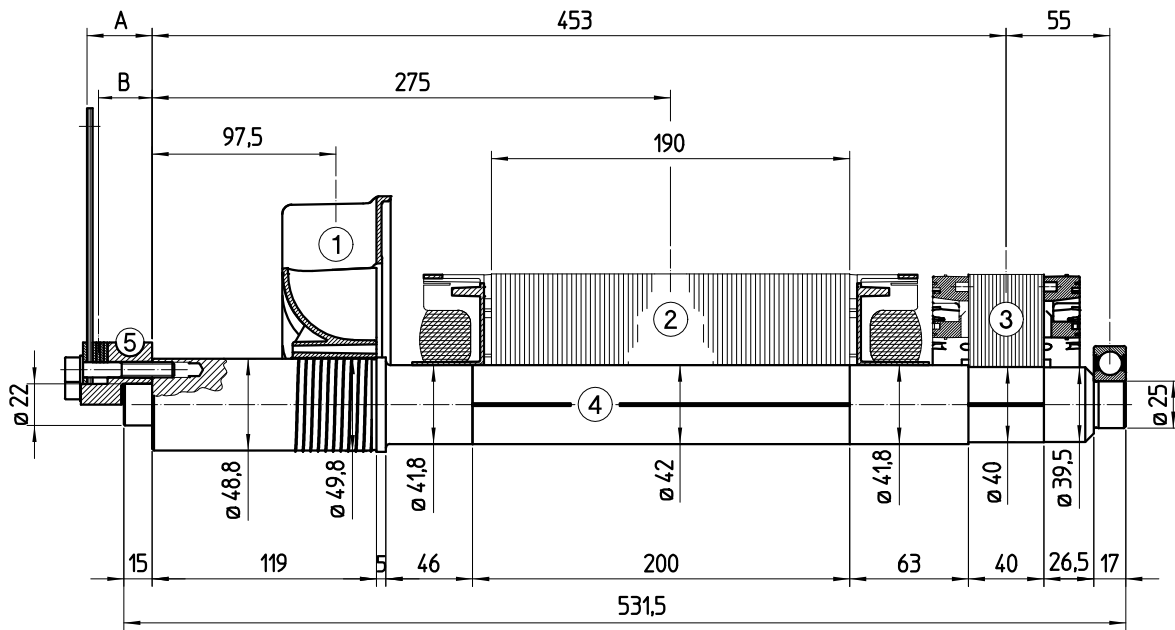

POS.	COMPONENT	WEIGHT (kg)	J (kgm ²)
1	FAN	0,4	0,00206
2	MAIN ROTOR	18,0	0,04342
3	EX. ROTOR	4,2	0,01086
4	SHAFT	5,8	0,00140
TOTAL		28,4	0,05774

SAE N°	SHAFTS COUPLING FLEX PLATE			
	A	B	WEIGHT kg	J kgm ²
5				
6 1/2	3	1,5	1,00	0,00495
7 1/2	3	1,5	1,20	0,00769
8	34,6	29,5	1,75	0,01114
10	26,6	23,5	2,14	0,02220
11 1/2	13	11	2,60	0,03524

SINGLE BEARING DIMENSIONS

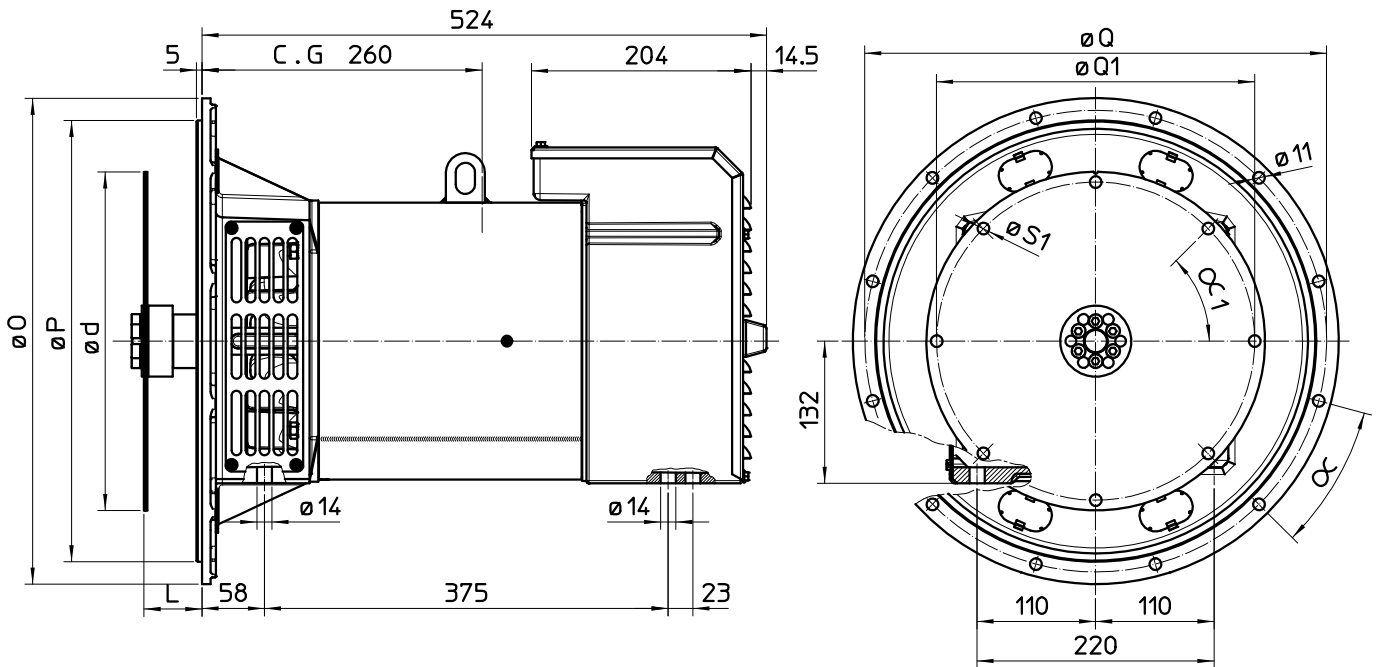

GIUNTO A DISCO / COUPLING DISC PLATEX						
SAE	L	d	Q1	Fori N° Holes N°	S1	α ₁
6 ‡	30,2	215,9	200	6	9	60°
7 ‡	30,2	241,3	222,25	8	9	45°
8	62	263,52	244,47	6	11	60°
10	53,8	314,52	295,27	8	11	45°
11 ‡	39,6	352,42	333,37	8	11	45°

FLANGIE / FLANGE					
SAE	O	P	Q	Fori N° Holes N°	α
6	308	266,7	285,75	8	22°30'
5	356	314,3	333,4	8	22°30'
4	403	362	381	12	15°
3	451	409,6	428,6	12	15°

C.G.= GRAVITY CENTER