

Electrical Characteristics										
Frequency	Hz	50				60				
Voltage (star)	V	380	400	415	440	415	440	460	480	
Rated power class H	kVA	66	66	65	55	68	75	79,5	79,5	
	kW	52,8	52,8	52	44	54,4	60	63,6	63,6	
Rated power class F	kVA	60	60	59	50	61,5	68	72	72	
	kW	48	48	47,2	40	49,2	54,4	57,6	57,6	
Regulation with	DSR	±1 % with any power factor and speed variations between -5% +30%								
Insulation class		H								
Execution		Brushless								
Stator winding		12 ends								
Rotor		with damping cage								
Efficiencies class H	4/4	%	88,3	88,4	88,1	87,9	89,5	90	90,1	90,2
(see graph. for details)	3/4	%	88,3	88,6	88,5	88,2	89,8	90	90,2	90,4
	2/4	%	85,4	85,5	85,5	85,2	86	86,1	86,2	86,3
	1/4	%	80,1	80	79,8	79,3	80,8	80,6	80,7	81
Reactances (f. l.cl. F)	Xd	%	518,2	468	427,9	322,1	535,2	525,1	509,3	468
	Xd'	%	13,96	12,6	11,53	8,68	14,42	14,15	13,72	12,6
	Xd''	%	6,87	6,2	5,67	4,27	7,09	6,96	6,75	6,2
	Xq	%	267,1	241,1	220,6	166,0	275,9	270,7	262,5	241,1
	Xq'	%	267,1	241,1	220,6	166,0	275,9	270,7	262,5	241,1
	Xq''	%	32,2	29,1	26,6	20,0	33,3	32,7	31,7	29,1
	X ₂	%	19,56	17,65	16,15	12,16	20,20	19,82	19,22	17,65
	X ₀	%	2,99	2,7	2,47	1,86	3,09	3,03	2,94	2,7
Short Circuit Ratio	Kcc		0,31	0,40	0,54	0,95	0,20	0,25	0,31	0,40
Time Constants	Td'	sec.	0,074							
	Td''	sec.	0,017							
	Td ₀ '	sec.	1,20							
	Tα	sec.	0,009							
Short Circuit Current Capacity		%	>300				>320			
Excitation at no load	Amp.		0,4	0,5	0,6	0,7	0,3	0,35	0,4	0,5
Excitation at full load	Amp.		1,4	1,5	1,6	1,7	1,2	1,2	1,3	1,4
Overload (long-term)		%	1 hour in a 6 hours period 110% rated load							
Overload per 20 sec.		%	300							
Stator Winding Resistance (20 °C)		Ω	0,043							
Rotor Winding Resistance (20 °C)		Ω	4,301							
Exciter Resistance (20 °C)		Ω	Rotor : 0,475				Stator : 11,35			
Heat dissipation at f.l.cl.H	W		6996	6929	7024	6057	6382	6667	6988	6910
Telephone Interference			THF < 2%				TIF < 50			
Radio interference			EN61000-6-3, EN61000-6-1. For others standards apply to factory							
Waveform Distors.(THD) at f. load	LL/LN %		3,5 / 3,2							
Waveform Distors.(THD) at no load	LL/LN %		4,4 / 3,9							
Mechanical characteristics										
Protection			IP 21 (other protection on request)							
DE bearing			6312-2Z							
NDE bearing			6309-2RS							
Weight of wound stator assembly	kg		68,2							
Weight of wound rotor assembly	kg		41,2							
Weight of complete generator	kg		212							
Maximun overspeed	rpm		4320							
Unbalanced magnetic pull at f.l.cl.F	kN/mm		4							
Cooling air requirement	m ³ /min		22,4				27			
Inertia Constant (H)	sec.		0,332				0,397			
Noise level at 1m/7m	dB(A)		88 / 77				93 / 80			

50 Hz

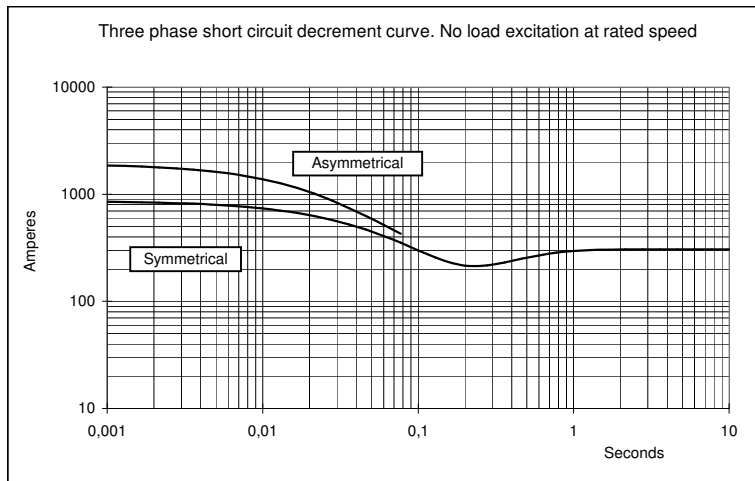

60 Hz

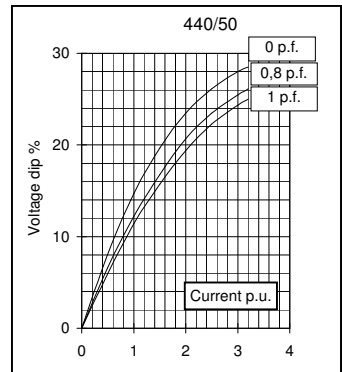
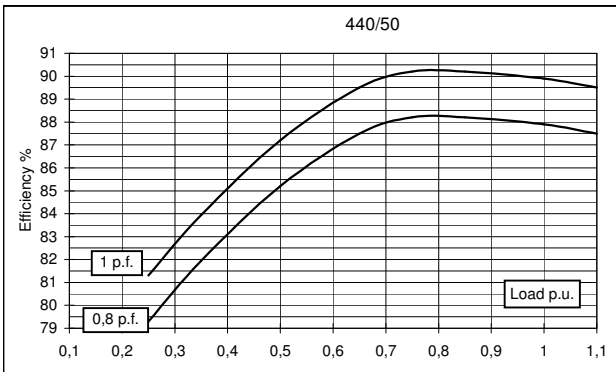
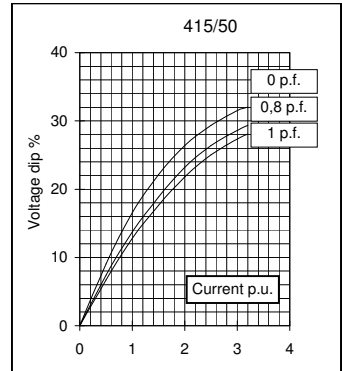
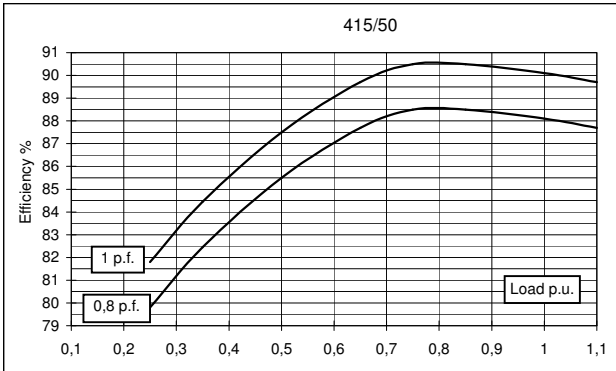
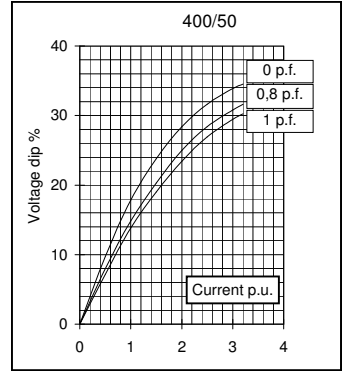
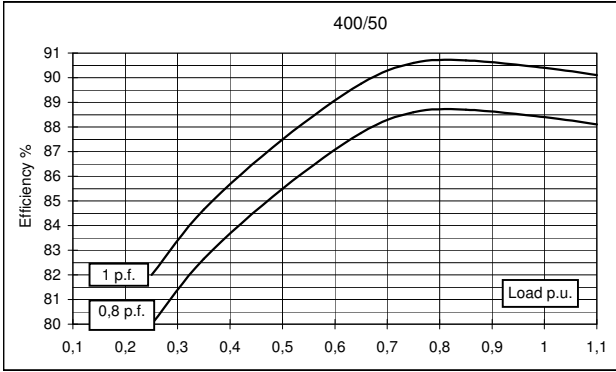
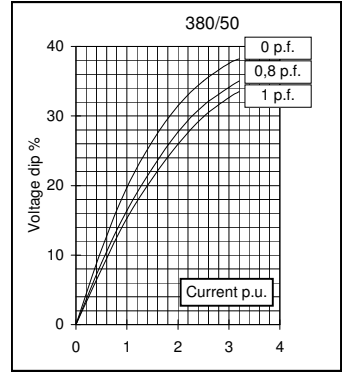
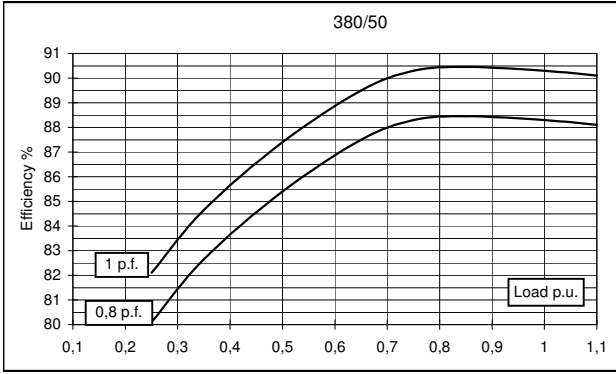
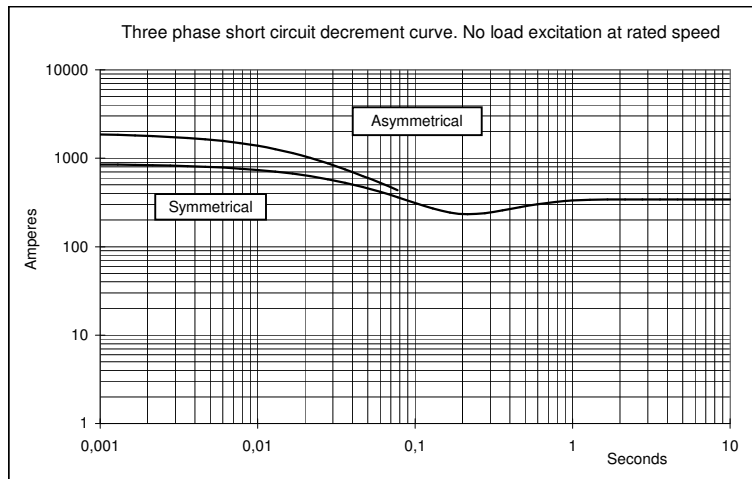
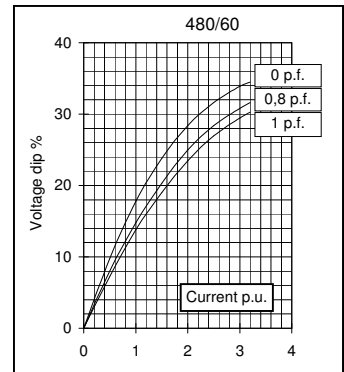
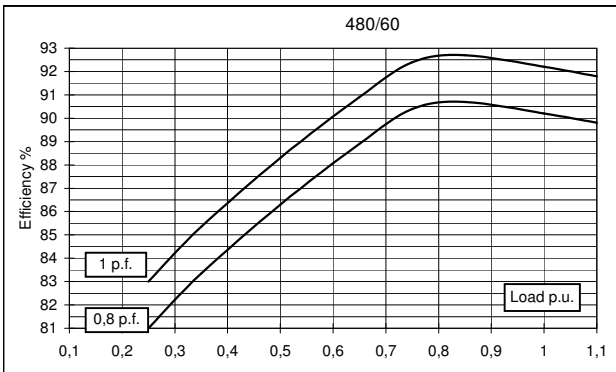
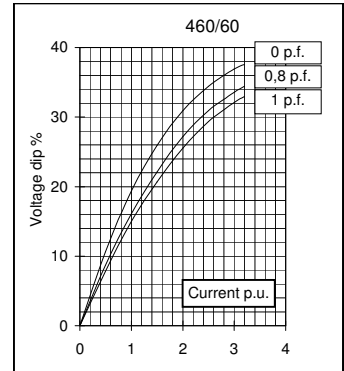
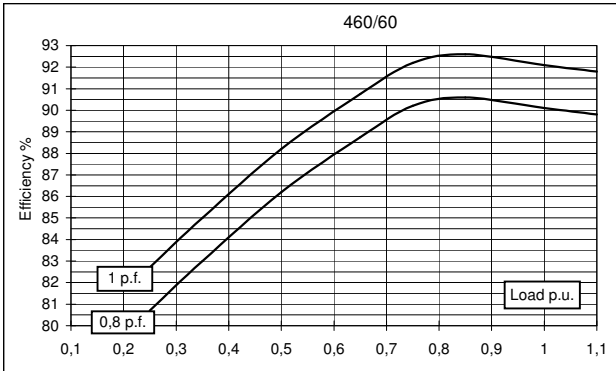
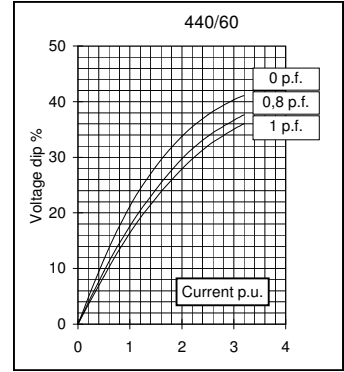
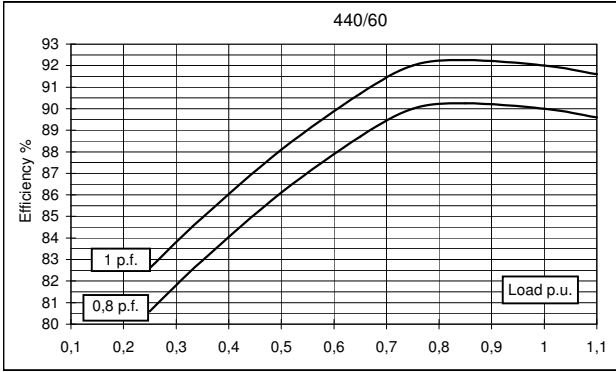
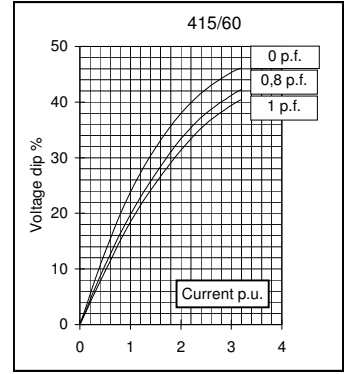
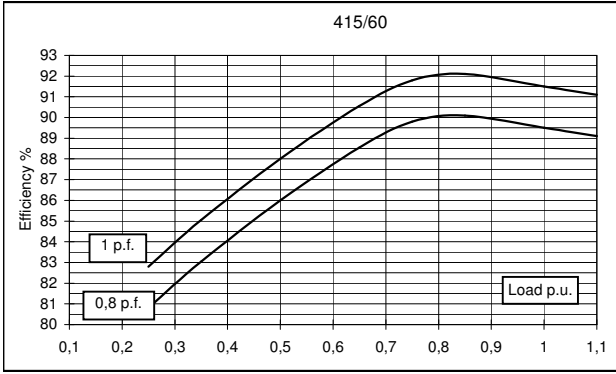

TWO BEARING MOMENTS OF INERTIA

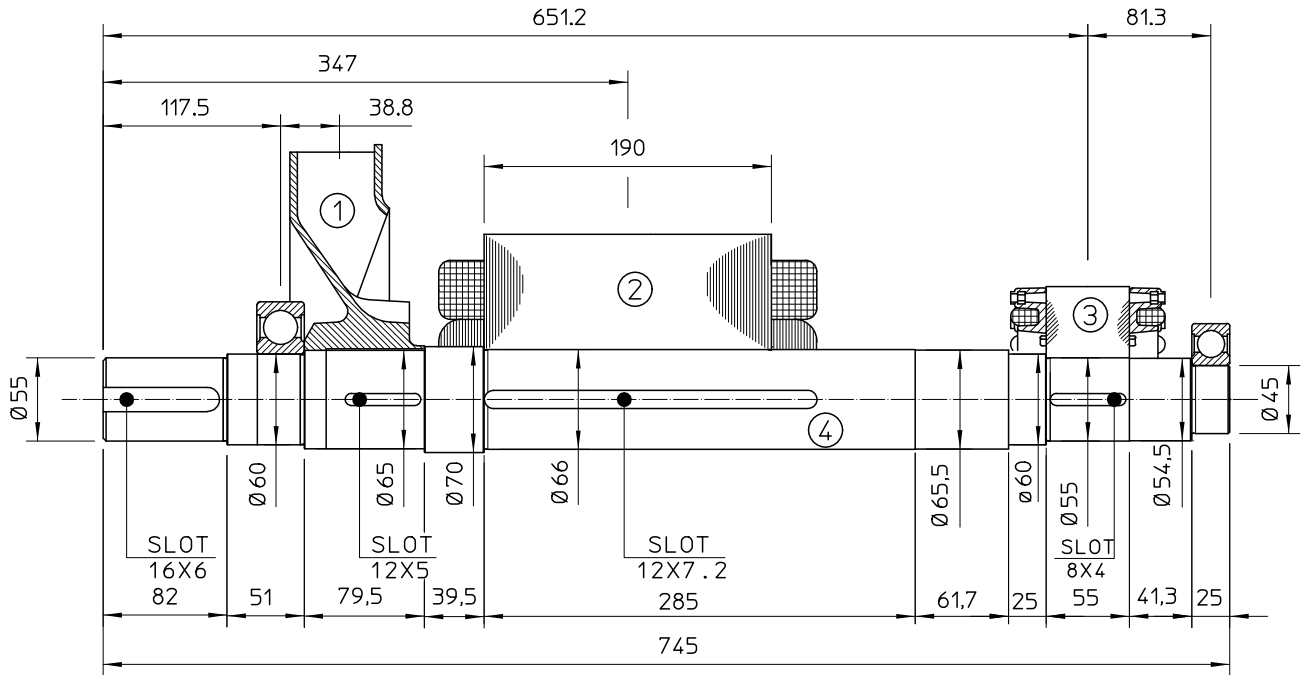

POS.	COMPONENT	WEIGHT (kg)	J (kgm ²)
1	FAN	2.3	0.0224
2	MAIN ROTOR	41.2	0.154
3	EX. ROTOR	7	0.016
4	SHAFT	17.5	0.008
TOTAL		68	0.2004

TWO BEARING DIMENSIONS

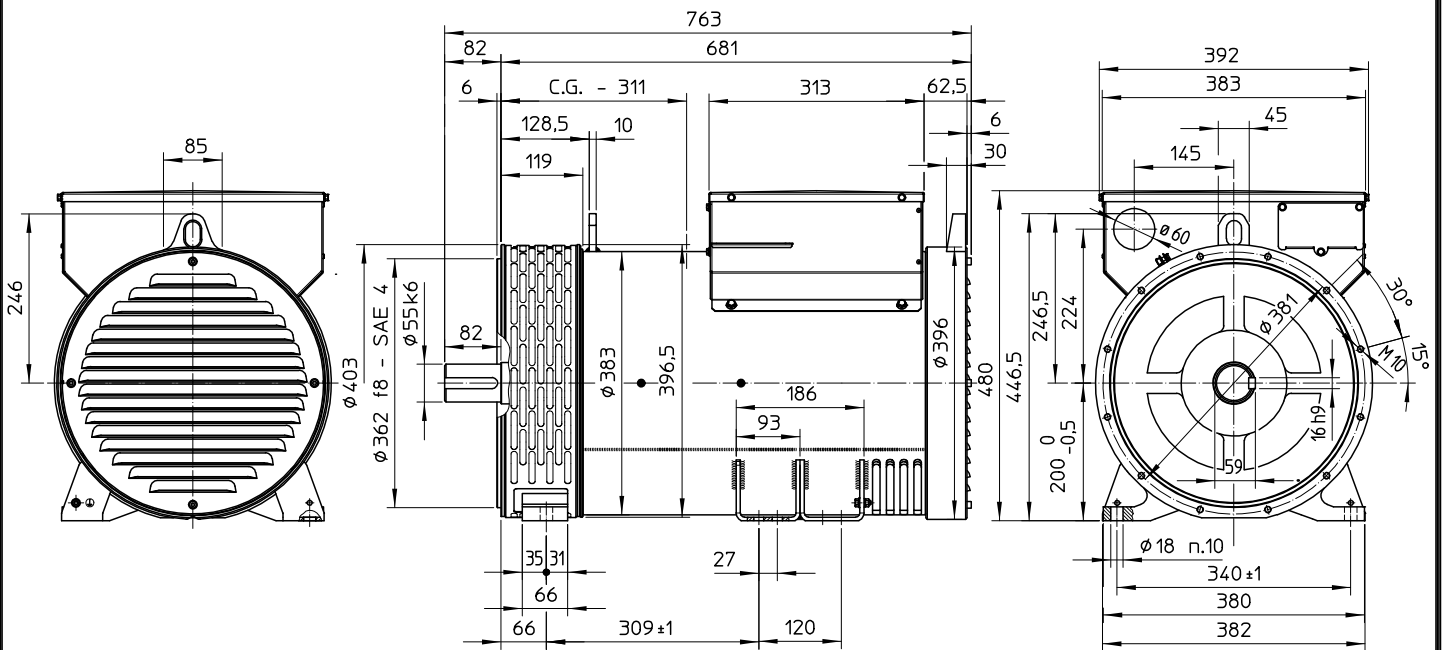

C.G.= GRAVITY CENTER

SINGLE BEARING MOMENTS OF INERTIA

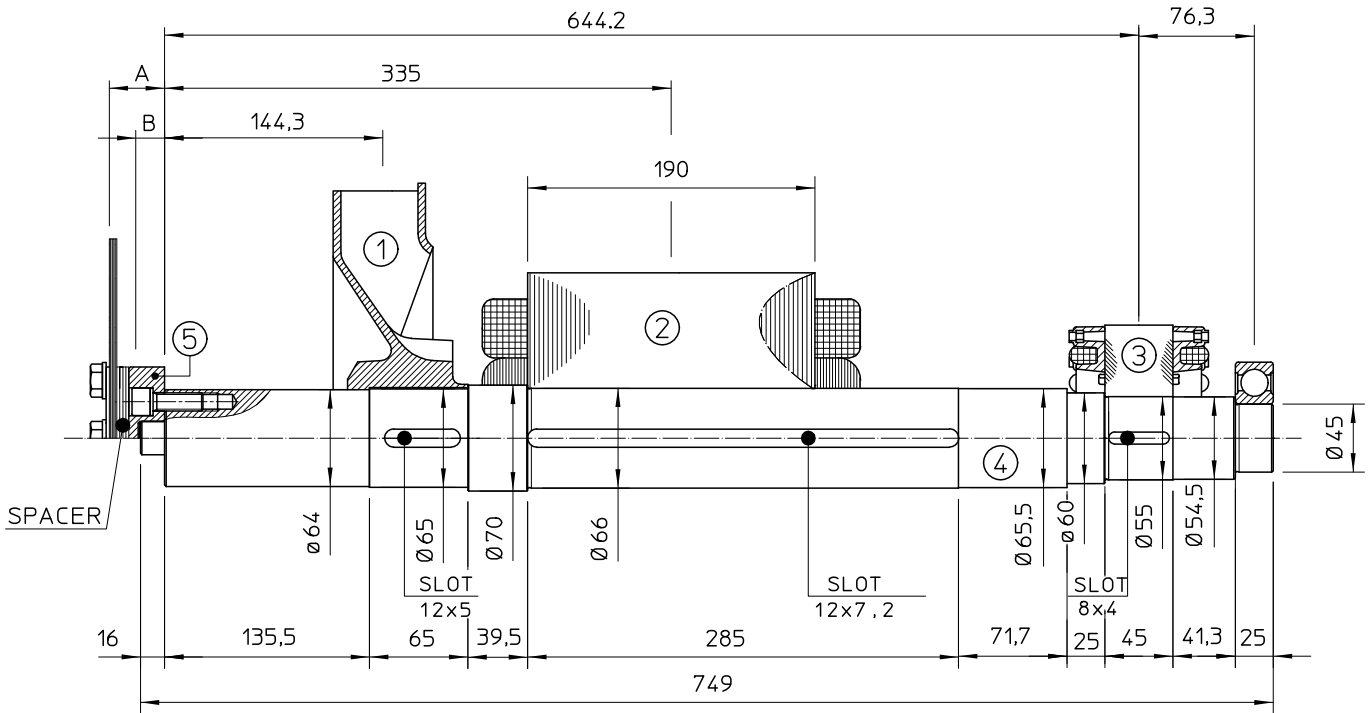

POS.	COMPONENT	WEIGHT (kg)	J (kgm ²)
1	FAN	2.3	0.0224
2	MAIN ROTOR	41.2	0.154
3	EX. ROTOR	7	0.016
4	SHAFT	18.3	0.0094
TOTAL		68.8	0.2018

SAE N°	5		SHAFTS COUPLING FLEX PLATE	
	A	B	WEIGHT kg	J kgm ²
6.5	5	2.5	1.74	0.0084
7.5	5	2.5	2.1	0.013
8	36.6	28.1	3.9	0.02
10	28.6	21.6	4.47	0.038
11.5	15	11.5	4.51	0.059

SINGLE BEARING DIMENSIONS

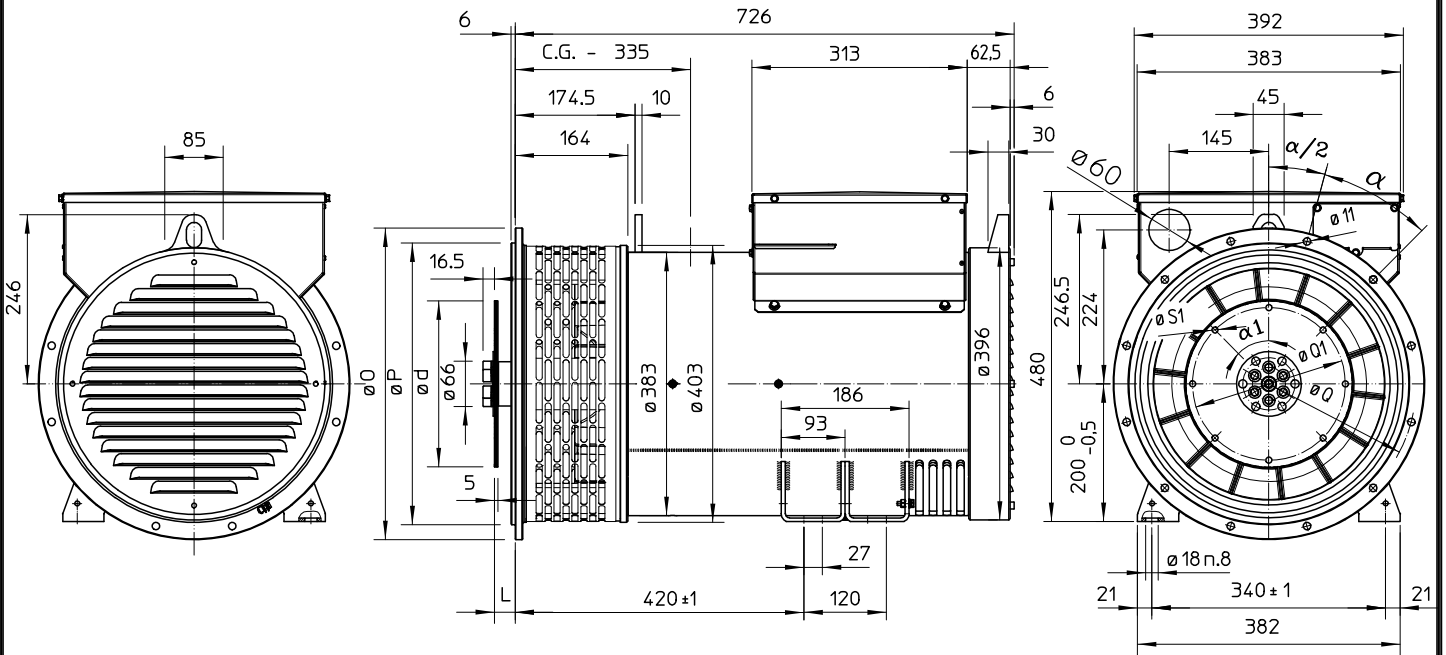

SAE N.	FLANGIA / FLANGE BRIDE / FLANSCH			
	O	P	Q	α
5	356	314.3	333.4	45°
4	403	362	381	30°
3	451	409.6	428.6	30°
2	490	447.7	466.7	30°
1	552	511.2	530.2	30°

SAE N.	GIUNTI A DISCHI / DISC COUPLING DISCQUE DE MONOPALIER / SCHEIBENKUPPLUNG				
	d	L	Q1	S1	α1
6 1/2	215.9	30.2	200	9	60°
7 1/2	241.3	30.2	222.25	9	45°
8	263.52	62	244.47	11	60°
10	314.32	53.8	295.27	11	45°
11 1/2	352.42	39.6	333.37	11	45°

C.G.= GRAVITY CENTER