



GENERATOR TYPE ECP 32-2S/2 A

Document : DS291A/1

issue 000 date 30/08/2013

Electrical Characteristics										
Frequency	Hz	50				60				
Voltage (star)	V	380	400	415	440	415	440	460	480	
Rated power class H	kVA	44	44	44	38	46	51	53	53	
	kW	35,2	35,2	35,2	30,4	36,8	40,8	42,4	42,4	
Rated power class F	kVA	40	40	40	34,5	41,5	46	48	48	
	kW	32	32	32	27,6	33,2	36,8	38,4	38,4	
Regulation with	DSR	±1 % with any power factor and speed variations between -5% +30%								
Insulation class		H								
Execution		Brushless								
Stator winding		12 ends								
Rotor		with damping cage								
Efficiencies class H	4/4	%	87,3	87,4	87,1	86,9	88,5	89	89,1	89,2
(see graph. for details)	3/4	%	87,4	87,7	87,6	87,3	88,9	89,1	89,3	89,5
	2/4	%	84,7	84,8	84,8	84,5	86,5	86,6	86,7	86,8
	1/4	%	80,1	80	79,8	79,3	80,8	80,6	80,7	81
Reactances (f. l.cl. F)	Xd	%	448,8	405	376,3	289,1	470,2	463,8	441,0	405
	Xd'	%	14,63	13,2	12,26	9,42	15,33	15,12	14,37	13,2
	Xd''	%	7,53	6,8	6,32	4,85	7,90	7,79	7,40	6,8
	Xq	%	251,5	227	210,9	162,0	263,6	260,0	247,2	227
	Xq'	%	251,5	227	210,9	162,0	263,6	260,0	247,2	227
	Xq''	%	30,5	27,5	25,5	19,6	31,9	31,5	29,9	27,5
	X ₂	%	17,95	16,2	15,05	11,56	18,81	18,55	17,64	16,2
	X ₀	%	3,21	2,9	2,69	2,07	3,37	3,32	3,16	2,9
Short Circuit Ratio	Kcc		0,37	0,47	0,63	1,15	0,20	0,27	0,37	0,47
Time Constants	Td'	sec.	0,069							
	Td''	sec.	0,016							
	Tdo'	sec.	1,10							
	Tα	sec.	0,015							
Short Circuit Current Capacity		%	>300				>320			
Excitation at no load	Amp.		0,5	0,6	0,7	0,8	0,3	0,4	0,5	0,6
Excitation at full load	Amp.		1,7	1,9	2	2,1	1,4	1,5	1,6	1,8
Overload (long-term)		%	1 hour in a 6 hours period 110% rated load							
Overload per 20 sec.		%	300							
Stator Winding Resistance (20 °C)	Ω		0,11							
Rotor Winding Resistance (20 °C)	Ω		3,65							
Exciter Resistance (20 °C)	Ω		Rotor : 0,417				Stator : 10,60			
Heat dissipation at f.l.cl.H	W		5121	5075	5213	4583	4782	5043	5187	5134
Telephone Interference			THF < 2%				TIF < 50			
Radio interference			EN61000-6-3, EN61000-6-1. For others standards apply to factory							
Waveform Distors.(THD) at f. load	LL/LN %		3,7 / 3,3							
Waveform Distors.(THD) at no load	LL/LN %		4,4 / 3,9							
Mechanical characteristics										
Protection			IP 21 (other protection on request)							
DE bearing			6312-2Z							
NDE bearing			6309-2RS							
Weight of wound stator assembly	kg		50							
Weight of wound rotor assembly	kg		24,6							
Weight of complete generator	kg		173							
Maximun overspeed	rpm		4320							
Unbalanced magnetic pull at f.l.cl.F	kN/mm		3,7							
Cooling air requirement	m ³ /min		22,4				27			
Inertia Constant (H)	sec.		0,371				0,443			
Noise level at 1m/7m	dB(A)		88 / 77				93 / 80			

All technical data are to be considered as a reference and they can be modified without any notice

This document is a propriety of Mecc Alte S.p.a..All rights reserved.

50 Hz

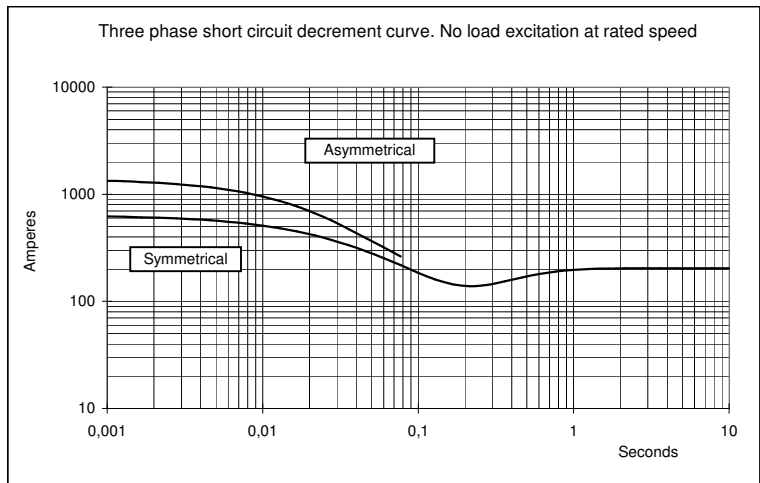
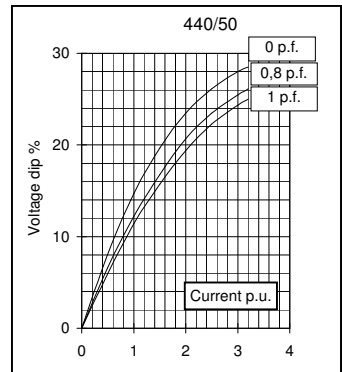
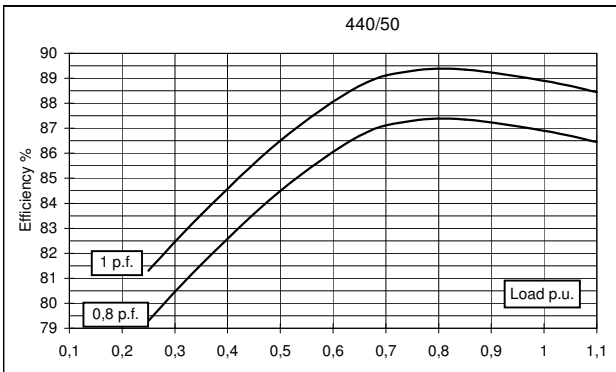
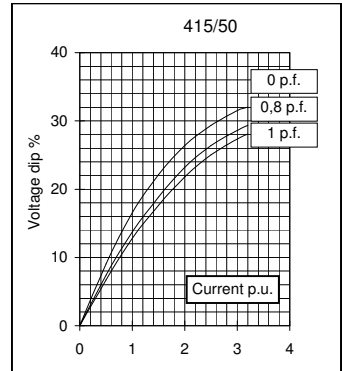
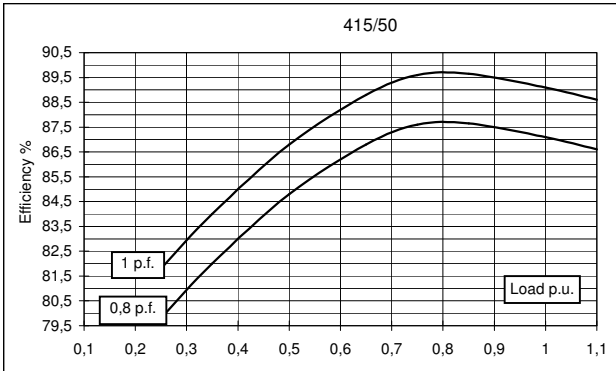
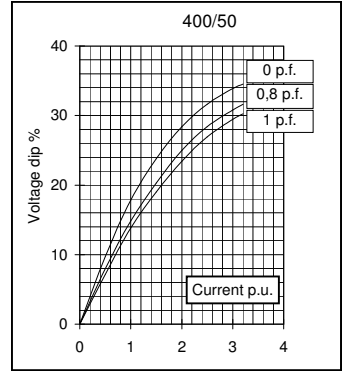
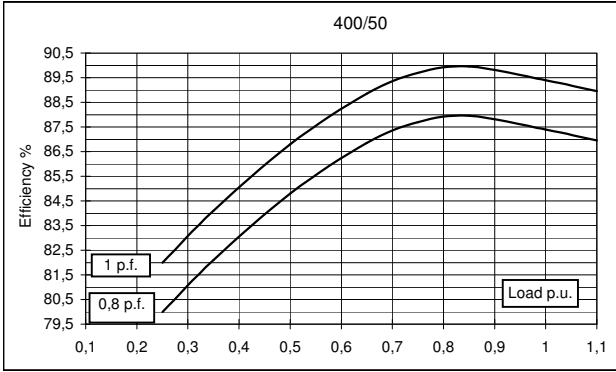
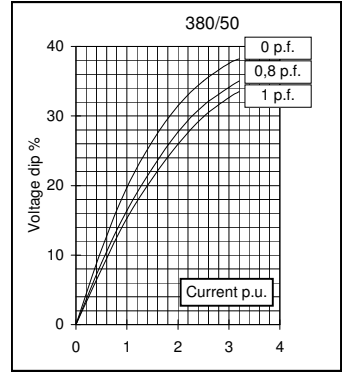
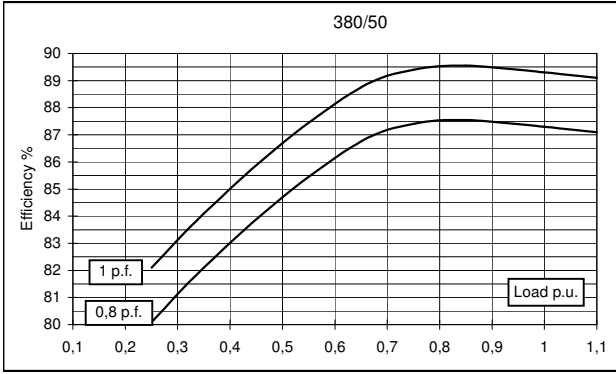

60 Hz

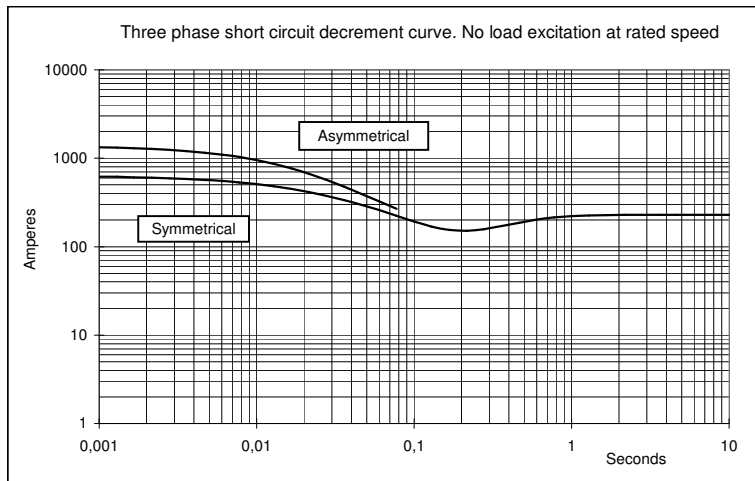
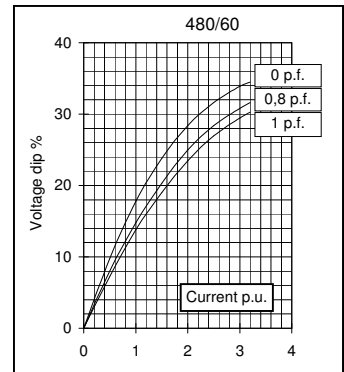
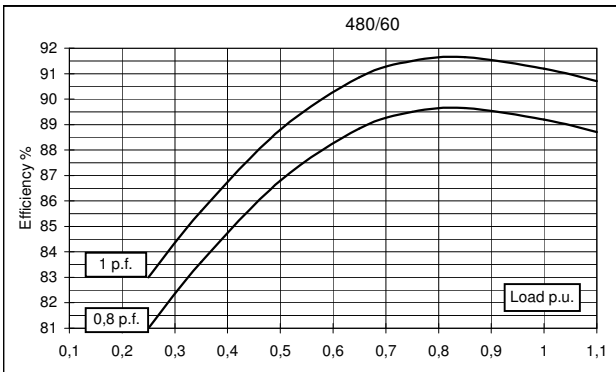
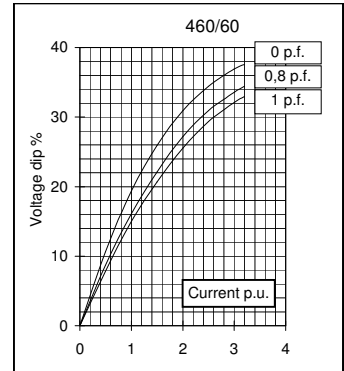
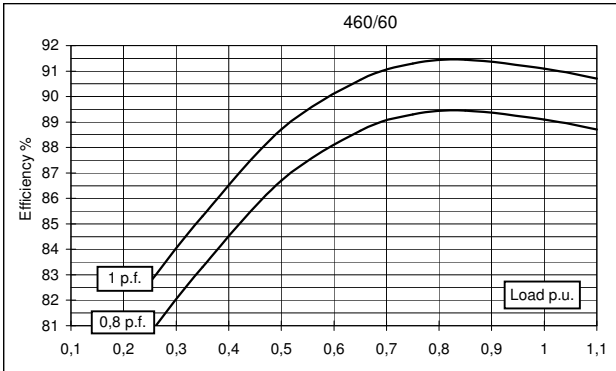
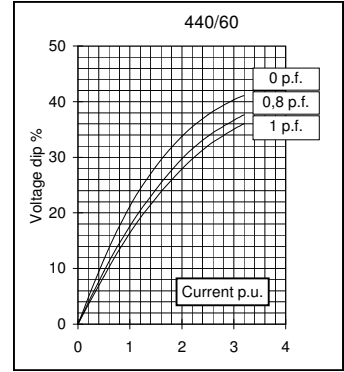
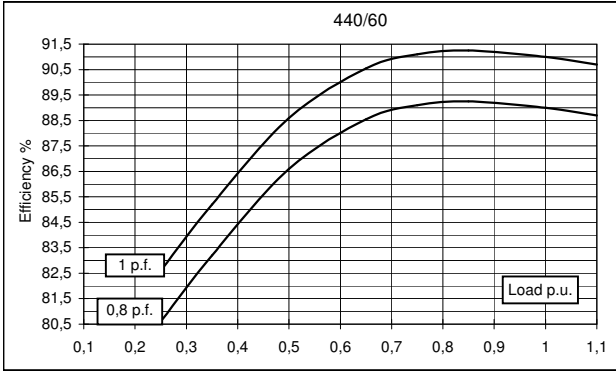
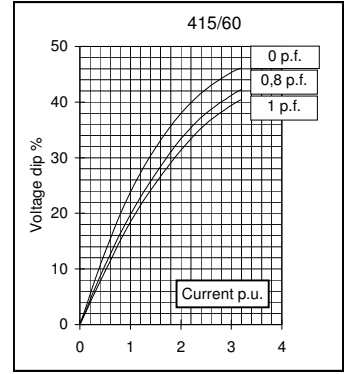
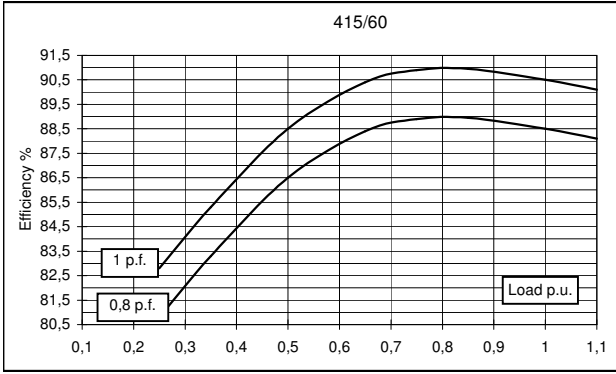

TWO BEARING MOMENTS OF INERTIA

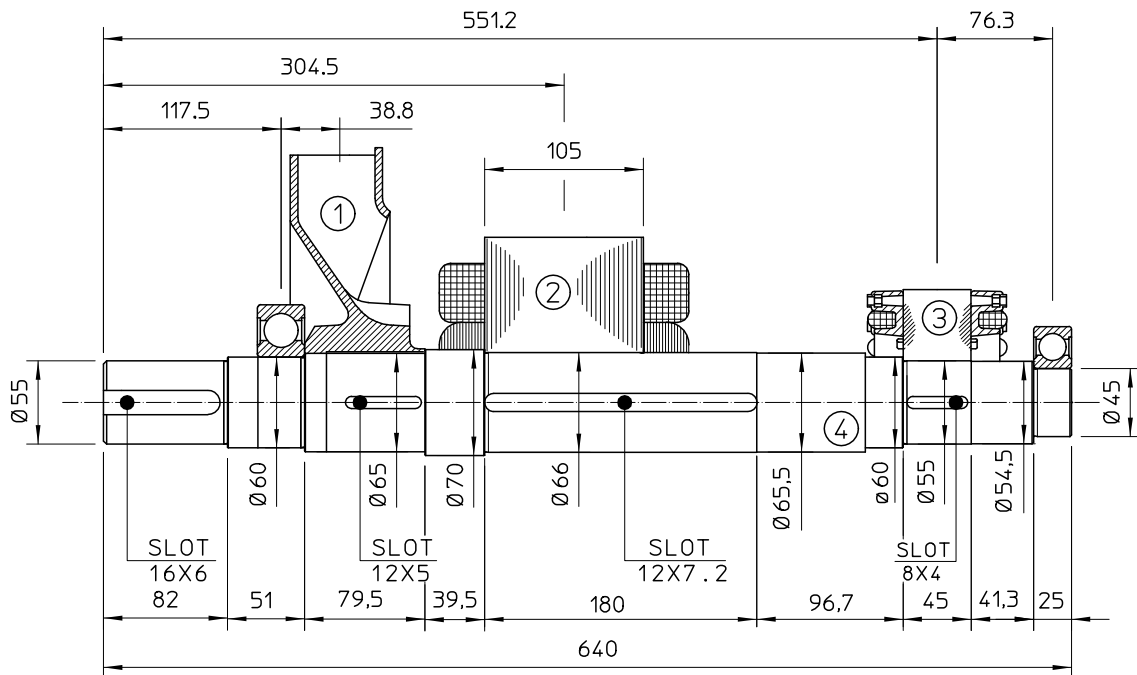

POS.	COMPONENT	WEIGHT (kg)	J (kgm ²)
1	FAN	2.3	0.0224
2	MAIN ROTOR	24.6	0.092
3	EX. ROTOR	5.4	0.012
4	SHAFT	15.1	0.007
TOTAL		47.4	0.1334

TWO BEARING DIMENSIONS

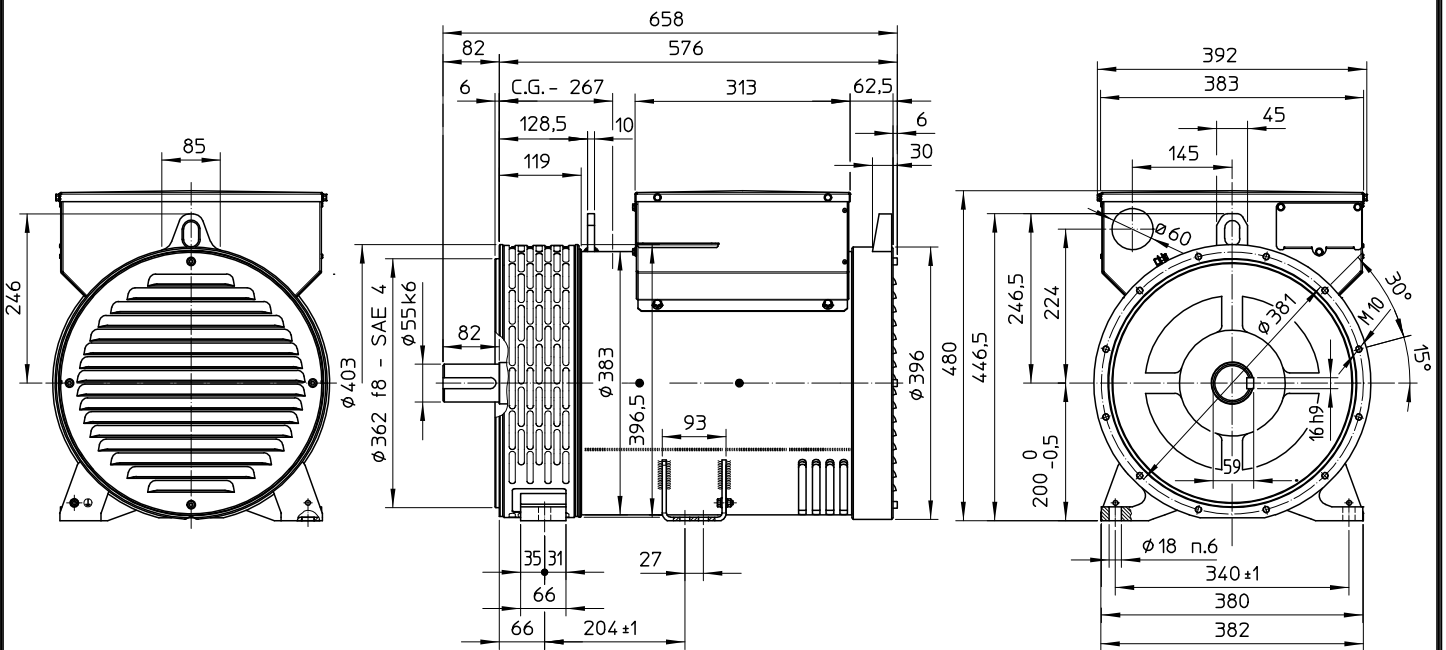

C.G.= GRAVITY CENTER

SINGLE BEARING MOMENTS OF INERTIA

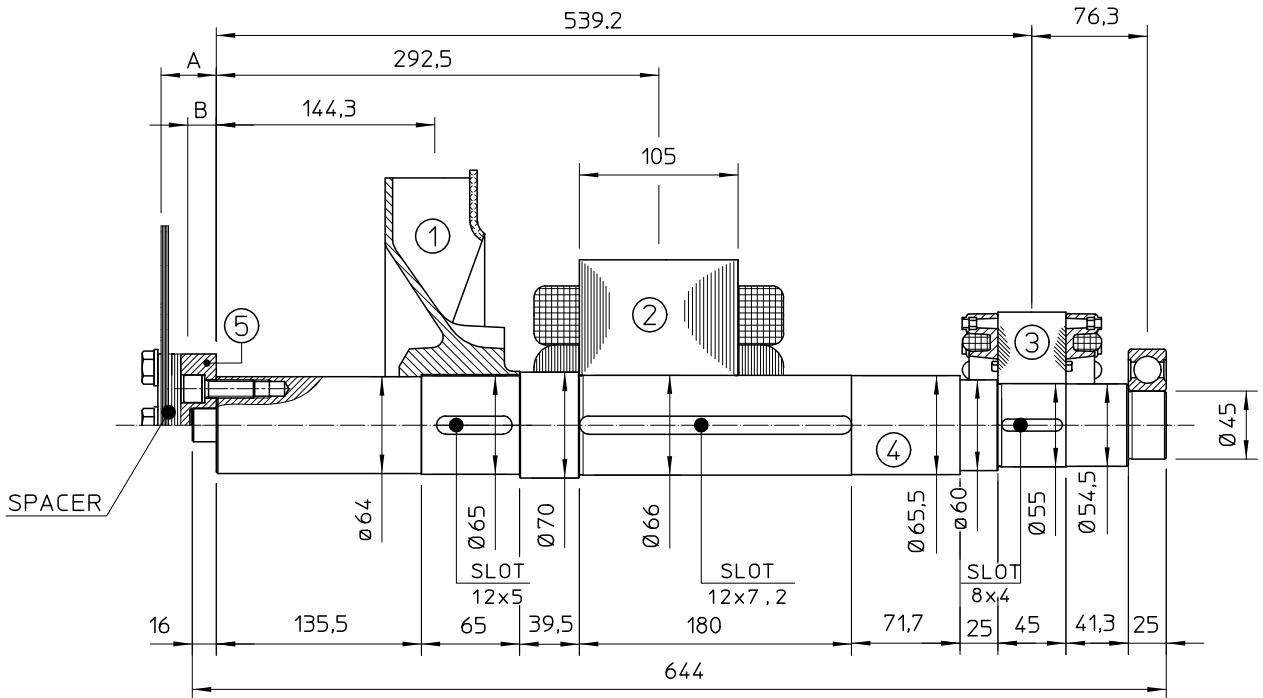

POS.	COMPONENT	WEIGHT (kg)	J (kgm ²)
1	FAN	2.3	0.0224
2	MAIN ROTOR	24.58	0.092
3	EX. ROTOR	5.4	0.012
4	SHAFT	15.5	0.0078
TOTAL		47.78	0.1342

SAE N°	5		SHAFTS COUPLING FLEX PLATE	
	A	B	WEIGHT kg	J kgm ²
6.5	5	2.5	1.74	0.0084
7.5	5	2.5	2.1	0.013
8	36.6	28.1	3.9	0.02
10	28.6	21.6	4.47	0.038
11.5	15	11.5	4.51	0.059

SINGLE BEARING DIMENSIONS

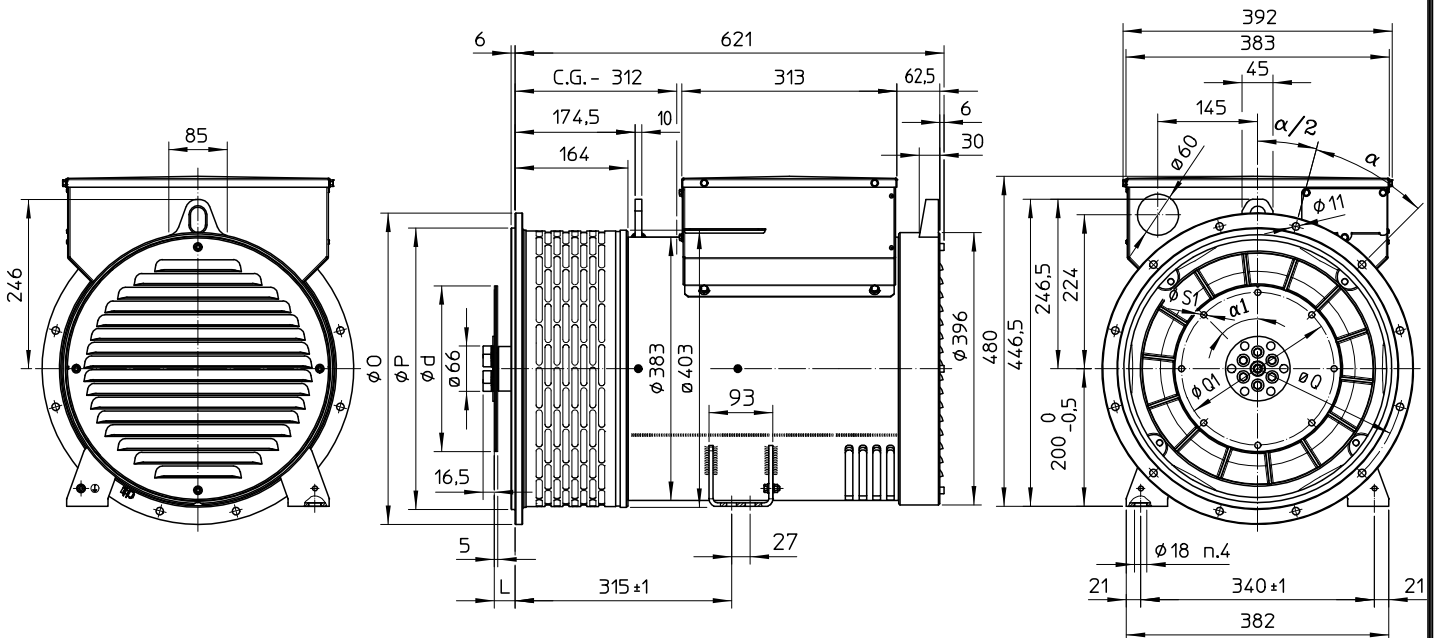

SAE N.	FLANGIA / FLANGE BRIDE / FLANSCH			
	O	P	Q	α
5	356	314.3	333.4	45°
4	403	362	381	30°
3	451	409.6	428.6	30°
2	490	447.7	466.7	30°
1	552	511.2	530.2	30°

SAE N.	GIUNTI A DISCHI / DISC COUPLING DISCQUE DE MONOPALIER / SCHEIBENKUPPLUNG				
	d	L	Q1	S1	α1
6 1/2	215.9	30.2	200	9	60°
7 1/2	241.3	30.2	222.25	9	45°
8	263.52	62	244.47	11	60°
10	314.32	53.8	295.27	11	45°
11 1/2	352.42	39.6	333.37	11	45°

C.G.= GRAVITY CENTER