

Electrical Characteristics										
Frequency	Hz	50				60				
Voltage (star)	V	380	400	415	440	415	440	460	480	
Rated power class H	kVA	8	8	8	6,8	8,5	9,6	9,6	9,6	
	kW	6,4	6,4	6,4	5,4	6,8	7,7	7,7	7,7	
Rated power class F	kVA	7,2	7,2	7,2	6	7	8,2	8,6	8,6	
	kW	5,8	5,8	5,8	4,8	5,6	6,6	6,9	6,9	
Regulation with	SR7/2	±1,5 % with any power factor and speed variations between -5% +30%								
Insulation class		H								
Execution		Brushless								
Stator winding		6 ends								
Rotor		with damping cage								
Efficiencies class H	4/4	%	78,4	78,5	78,2	78	79,2	79,7	79,8	79,9
(see graph. for details)	3/4	%	79,2	79,5	79,4	79,1	80,2	80,4	80,6	80,8
	2/4	%	75,9	76	76	75,7	77,1	77,2	77,3	77,4
	1/4	%	72,1	72	71,8	71,3	72,8	72,6	72,7	73
Reactances (f. l.cl. F)	Xd	%	380,1	343	318,7	241,0	406,3	408,2	373,5	343
	Xd'	%	36,57	33	30,66	23,18	39,09	39,27	35,93	33
	Xd''	%	20,61	18,6	17,28	13,07	22,03	22,14	20,25	18,6
	Xq	%	106,4	96	89,2	67,4	113,7	114,2	104,5	96
	Xq'	%	106,4	96	89,2	67,4	113,7	114,2	104,5	96
	Xq''	%	46,6	42,1	39,1	29,6	49,9	50,1	45,8	42,1
	X ₂	%	21,05	19	17,65	13,35	22,51	22,61	20,69	19
	X ₀	%	8,09	7,3	6,78	5,13	8,65	8,69	7,95	7,3
Short Circuit Ratio	Kcc		0,33	0,45	0,66	1,50	0,25	0,28	0,33	0,45
Time Constants	Td'	sec.	0,068							
	Td''	sec.	0,014							
	Tdo'	sec.	0,55							
	T _α	sec.	0,005							
Short Circuit Current Capacity		%	>300				>320			
Excitation at no load	Amp.		0,2	0,25	0,3	0,4	0,17	0,18	0,2	0,22
Excitation at full load	Amp.		1,1	1,12	1,2	1,3	0,8	0,9	1	1,1
Overload (long-term)		%	1 hour in a 6 hours period 110% rated load							
Overload per 20 sec.		%	300							
Stator Winding Resistance (20°C)	Ω		1,608							
Rotor Winding Resistance (20°C)	Ω		6,702							
Exciter Resistance (20 °C)	Ω		Rotor : 1,453				Stator : 15,71			
Heat dissipation at f.l.cl.H	W		1763	1753	1784	1534	1786	1956	1944	1932
Telephone Interference			THF < 2%				TIF < 45			
Radio interference			EN60034-1, VDE0875K. For others standards apply to factory.							
Waveform Distors.(THD) at f. load	LL/LN %		4,9 / 4,8							
Waveform Distors.(THD) at no load	LL/LN %		4,2 / 4,1							
Mechanical characteristics										
Protection			IP 23 (other protection on request)							
DE bearing			6308-2RS							
NDE bearing			6305-2RS							
Weight of wound stator assembly	kg		17,5							
Weight of wound rotor assembly	kg		9,5							
Weight of complete generator	kg		57							
Maximun overspeed	rpm		4500							
Unbalanced magnetic pull at f.l.cl.F	kN/mm		2,4							
Cooling air requirement	m ³ /min		6,4				7,8			
Inertia Constant (H)	sec.		0,22				0,264			
Noise level at 1m/7m	dB(A)		85 / 70				89 / 73			

All technical data are to be considered as a reference and they can be modified without any notice.

This document is a propriety of Mecc Alte S.p.a..All rights reserved.

50 Hz

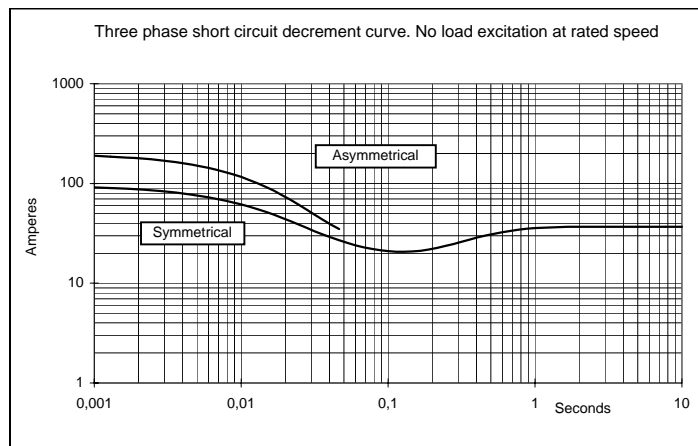
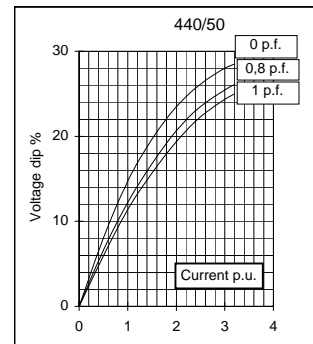
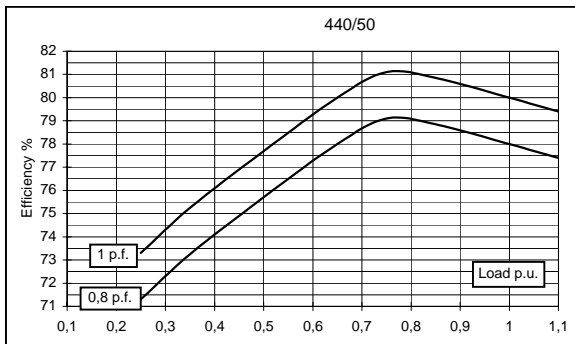
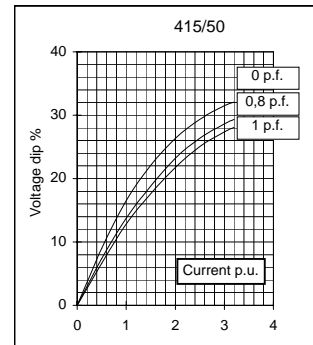
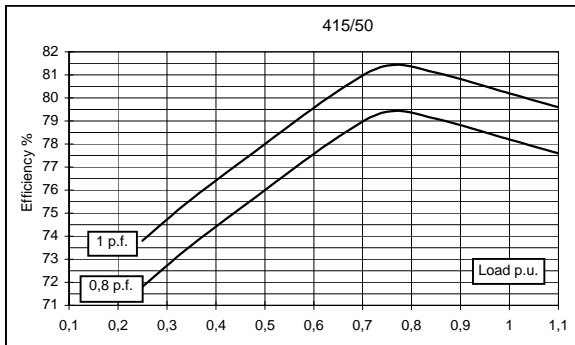
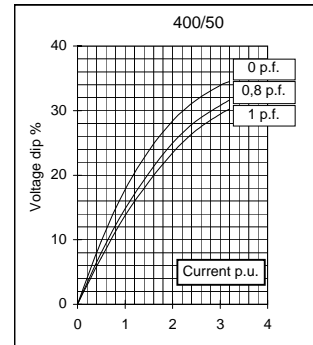
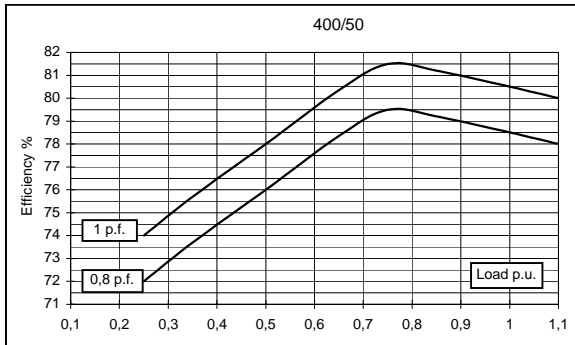
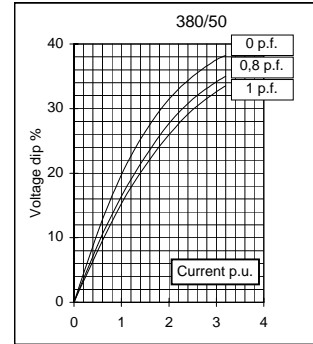
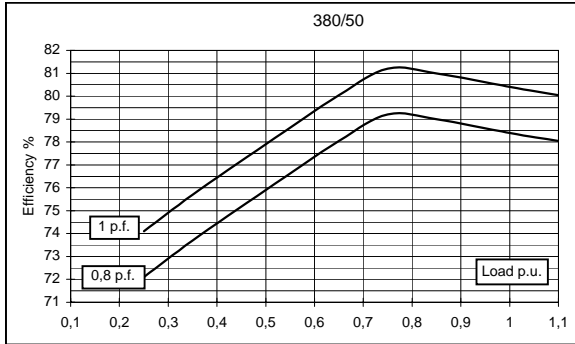

60 Hz

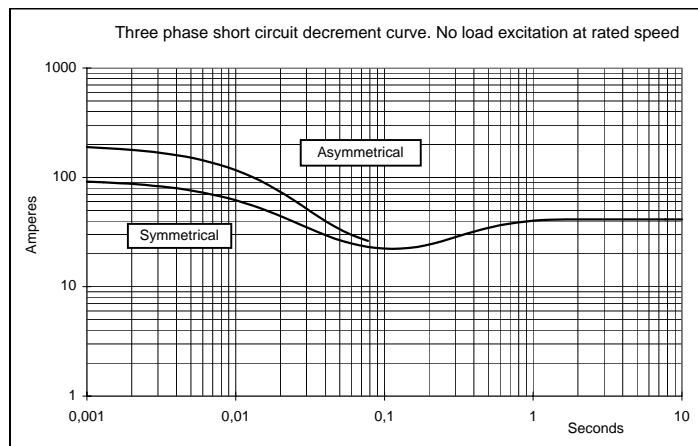
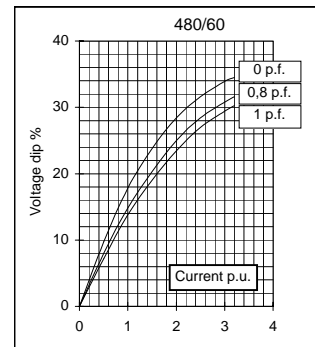
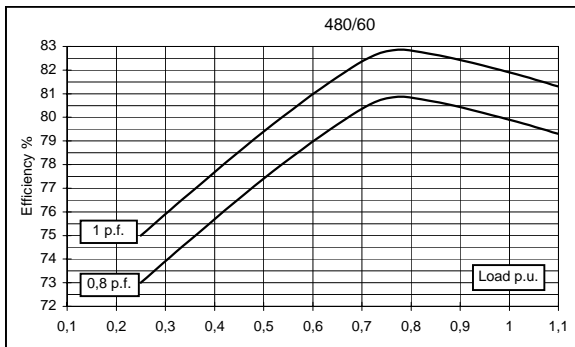
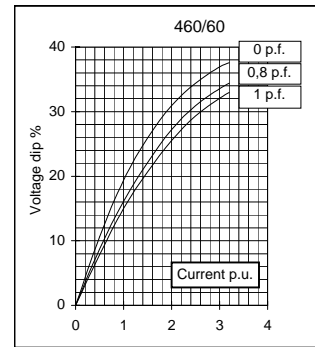
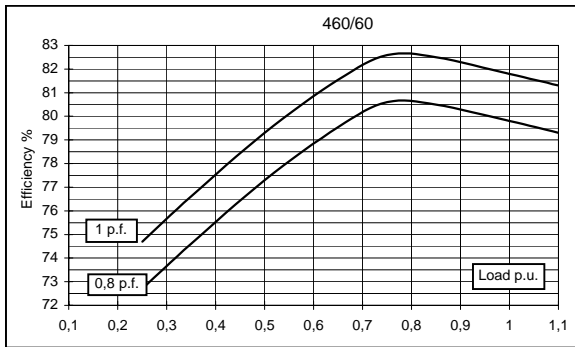
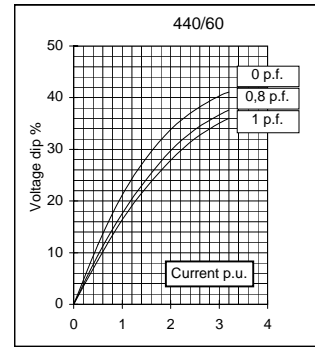
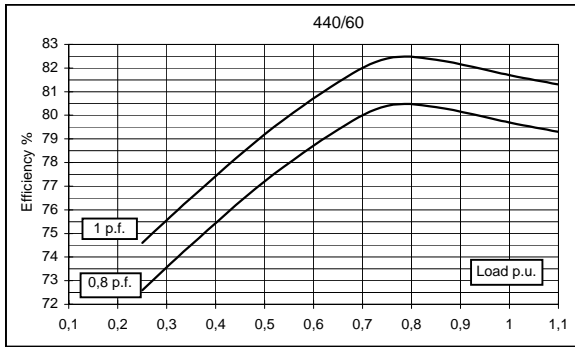
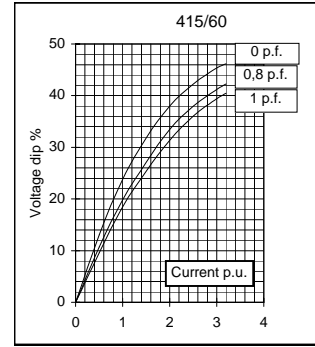
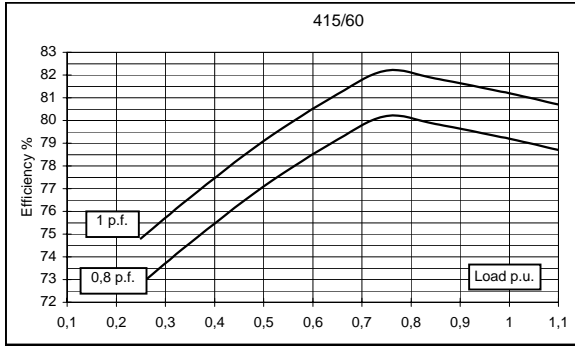

TWO BEARING MOMENTS OF INERTIA

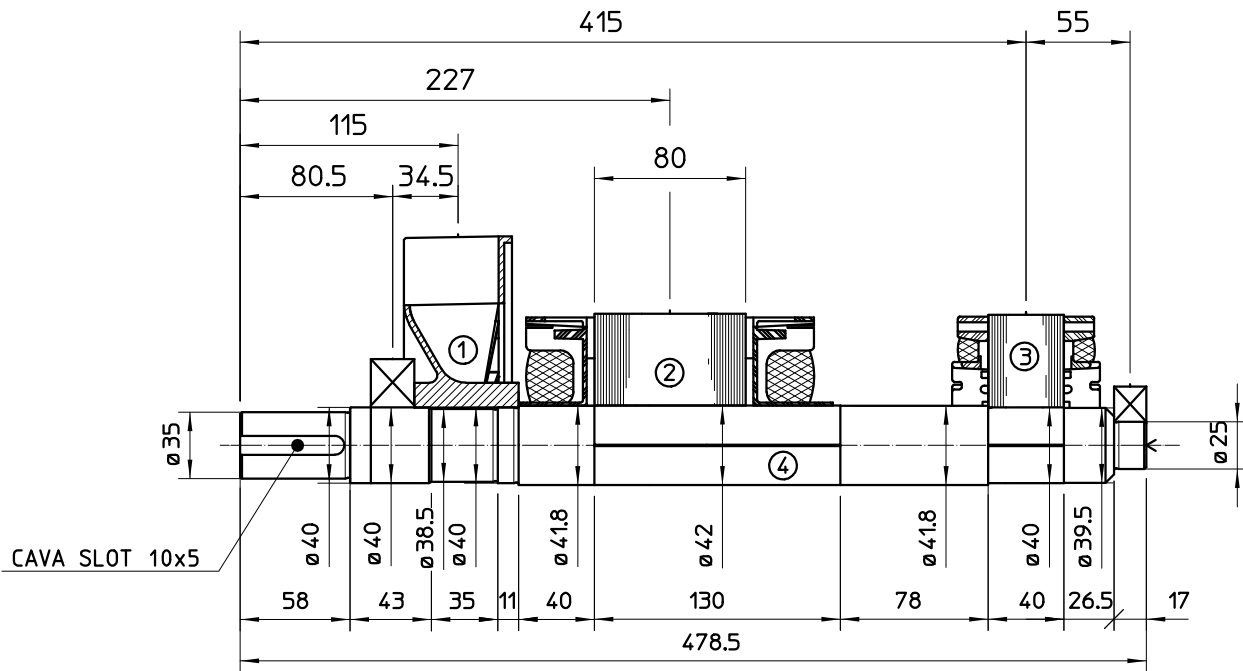

COMPONENT	WEIGHT Kg	J Kg ²
1 FAN	0.93	0.0036
2 MAIN ROTOR	8.32	0.020
3 EX ROTOR	4.12	0.011
4 SHAFT	4.7	0.00097
6 TOTAL	18.07	0.03557

TWO BEARING DIMENSIONS

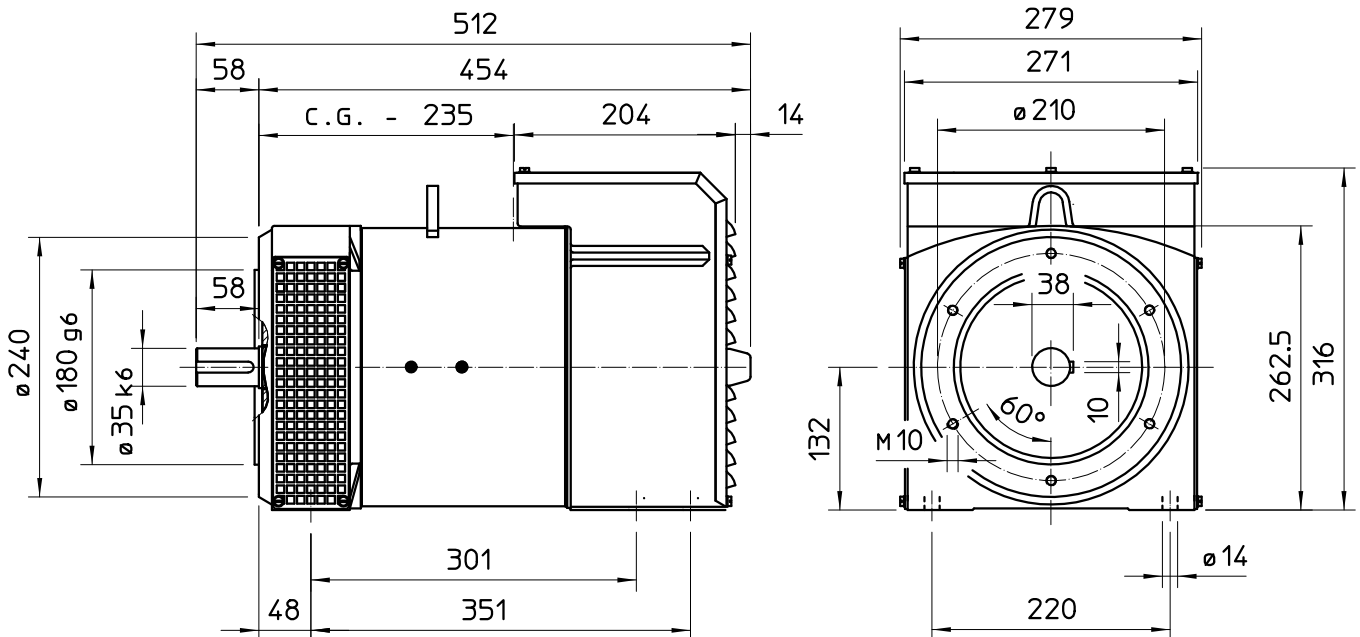

SINGLE BEARING MOMENTS OF INERTIA

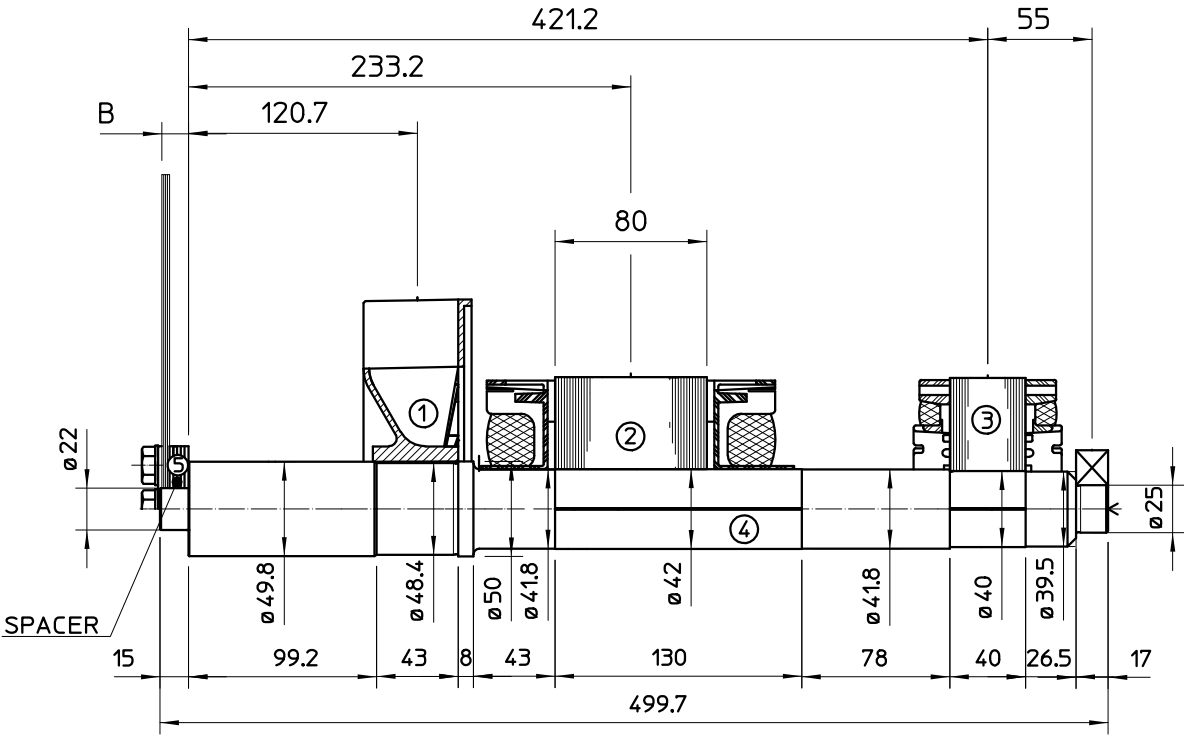

COMPONENT	WEIGHT Kg	J Kg ^m ²
1 FAN	0.82	0.0032
2 MAIN ROTOR	8.32	0.020
3 EX ROTOR	4.12	0.011
4 SHAFT	5.6	0.0012
TOTAL	18.86	0.0354

SAE N.	SHAFT COUPLING FLEX PLATE		
	B(mm)	WEIGHT kg	J kgm ²
6 1/2	4	1.14	0.0067
7 1/2	4	1.42	0.0103
8	35.6	1.97	0.0171
10	27.6	2.59	0.0319
11 1/2	14	3.1	0.0481

SINGLE BEARING DIMENSIONS

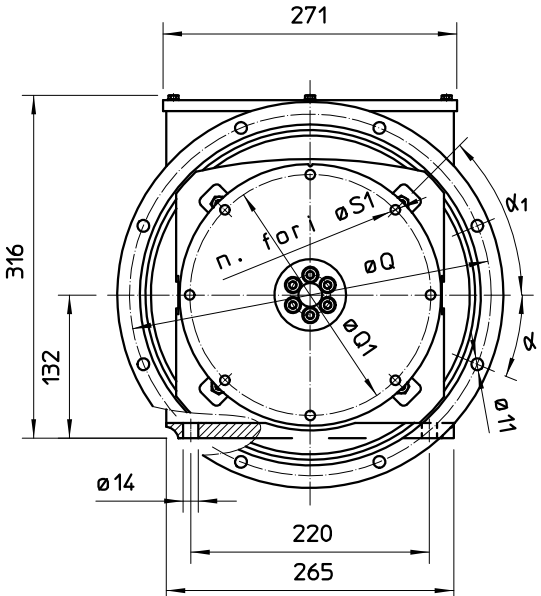
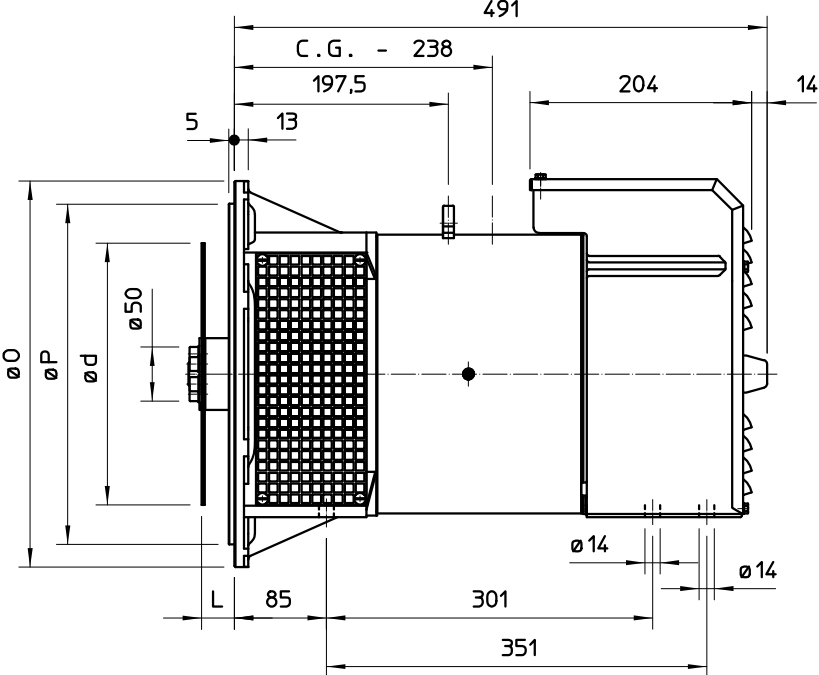

GIUNTI A DISCO COUPLING DISC PLATEX
DISQUE DE MONOPALIER SCHEIBENKUPPLUNG
JUNTAS A DISCOS

FLANGIA FLANGE BRIDE FLANSCH BRIDAS	SAE N.	O	P	Q	n. for i	α
	6	308	266.7	285.75	8	22°30'
	5	356	314.3	333.4	8	22°30'
	4	403	362	381	12	15°
	3	451	409.6	428.6	12	15°

SAE N.	L	d	Q1	n. for i	S1	α1
6 1/2	30.2	215.9	200	6	9	60°
7 1/2	30.2	241.3	222.25	8	9	45°
8	62	263.52	244.47	6	11	60°
10	53.8	314.32	295.27	8	11	45°
11 1/2	39.6	352.42	333.37	8	11	45°

C.G. = GRAVITY CENTER