

Electrical Characteristics										
Frequency	Hz	50				60				
Voltage (star)	V	380	400	415	440	415	440	460	480	
Rated power class H	kVA	8	8	8	6,8	9	9,6	9,6	9,6	
	kW	6,4	6,4	6,4	5,4	7,2	7,7	7,7	7,7	
Rated power class F	kVA	7,5	7,5	7,5	6,4	7,5	8	9	9	
	kW	6	6	6	5,1	6	6,4	7,2	7,2	
Regulation with	SR7/2	±1,5 % with any power factor and speed variations between -5% +30%								
Insulation class		H								
Execution		Brushless								
Stator winding		6 ends								
Rotor		without damping cage								
Efficiencies class H	4/4	%	83,6	83,7	83,4	83,2	84,7	85,2	85,3	85,4
(see graph. for details)	3/4	%	84,4	84,7	84,6	84,3	85,7	85,9	86,1	86,3
	2/4	%	80,3	80,4	80,4	80,1	81,6	81,7	81,8	81,9
	1/4	%	75,5	75,6	75,4	74,9	76,8	76,6	76,7	77
Reactances (f. l.cl. F)	Xd	%	201,7	182	169,1	127,9	228,3	216,6	198,2	182
	Xd'	%	18,17	16,4	15,24	11,52	20,57	19,52	17,86	16,4
	Xd''	%	13,07	11,8	10,96	8,29	14,80	14,04	12,85	11,8
	Xq	%	66,6	60,1	55,8	42,2	75,4	71,5	65,4	60,1
	Xq'	%	66,6	60,1	55,8	42,2	75,4	71,5	65,4	60,1
	Xq''	%	71,2	64,3	59,7	45,2	80,6	76,5	70,0	64,3
	X ₂	%	17,95	16,2	15,05	11,38	20,32	19,28	17,64	16,2
	X ₀	%	6,32	5,7	5,30	4,00	7,15	6,78	6,21	5,7
Short Circuit Ratio	Kcc		0,66	0,8	0,99	1,61	0,53	0,61	0,66	0,8
Time Constants	Td'	sec.	0,017							
	Td''	sec.	0,011							
	Tdo'	sec.	0,73							
	T _α	sec.	0,012							
Short Circuit Current Capacity		%	>300				>320			
Excitation at no load	Amp.		0,25	0,29	0,32	0,35	0,2	0,23	0,25	0,27
Excitation at full load	Amp.		0,7	0,8	0,9	1	0,6	0,65	0,7	0,75
Overload (long-term)		%	1 hour in a 6 hours period 110% rated load							
Overload per 20 sec.		%	300							
Stator Winding Resistance (20°C)	Ω		1,272							
Rotor Winding Resistance (20°C)	Ω		7,141							
Exciter Resistance (20 °C)	Ω		Rotor : 1,453				Stator : 15,71			
Heat dissipation at f.l.cl.H	W		1256	1246	1274	1098	1301	1334	1324	1313
Telephone Interference			THF < 2%				TIF < 45			
Radio interference			EN60034-1, VDE 0875K. For others standards apply to factory							
Waveform Distors.(THD) at f. load	LL/LN %		2,8 / 2,4							
Waveform Distors.(THD) at no load	LL/LN %		2,7 / 2,5							
Mechanical characteristics										
Protection			IP 23 (other protection on request)							
DE bearing			6308-2RS							
NDE bearing			6305-2RS							
Weight of wound stator assembly	kg		20,9							
Weight of wound rotor assembly	kg		11,3							
Weight of complete generator	kg		70							
Maximun overspeed	rpm		2250							
Unbalanced magnetic pull at f.l.cl.F	kN/mm		2,8							
Cooling air requirement	m³/min		3,5				4,1			
Inertia Constant (H)	sec.		0,101				0,122			
Noise level at 1m/7m	dB(A)		72 / 58				78 / 60			

50 Hz

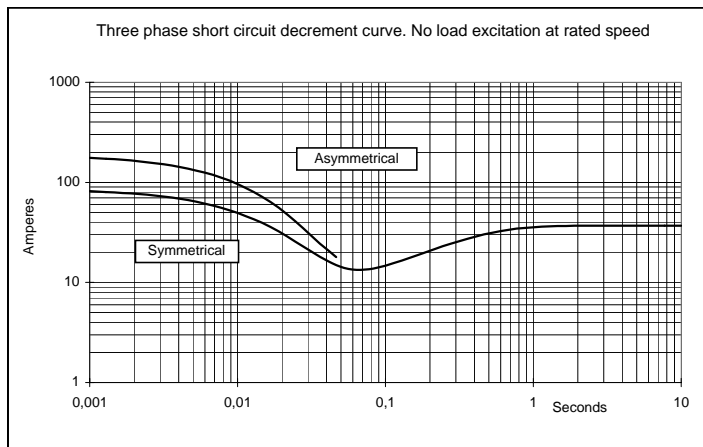

60 Hz

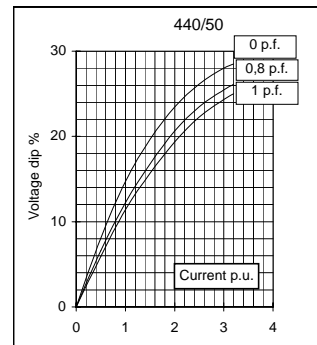
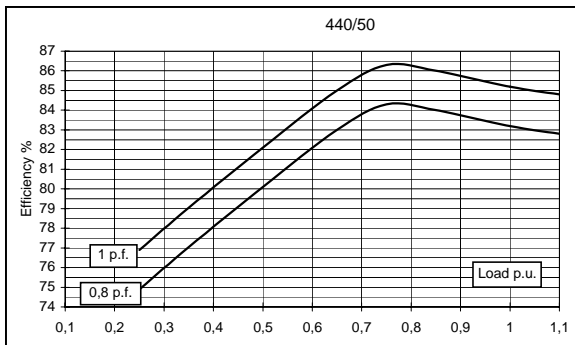
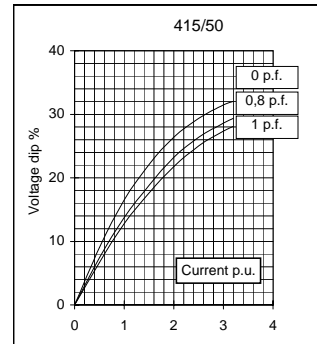
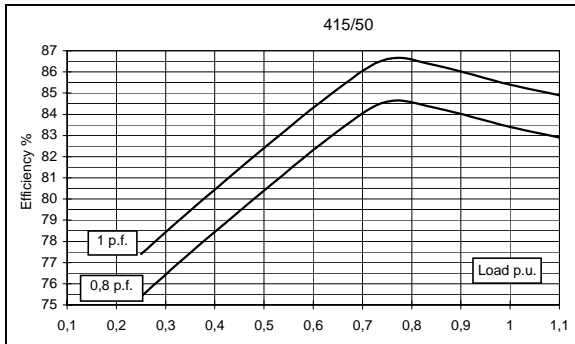
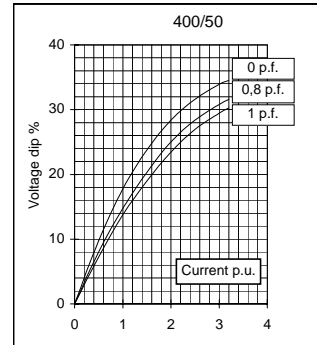
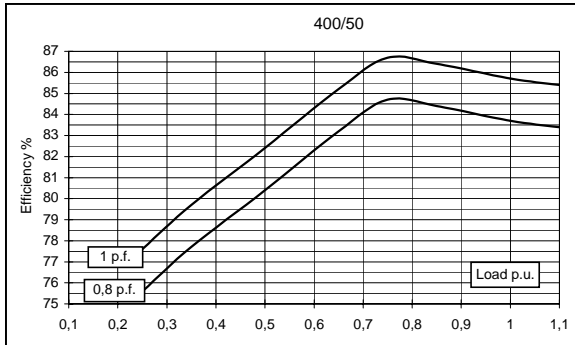
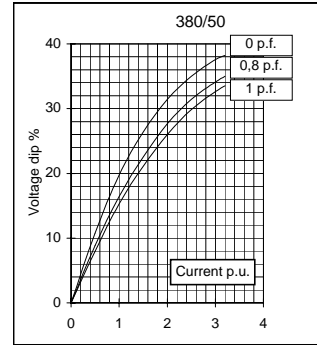
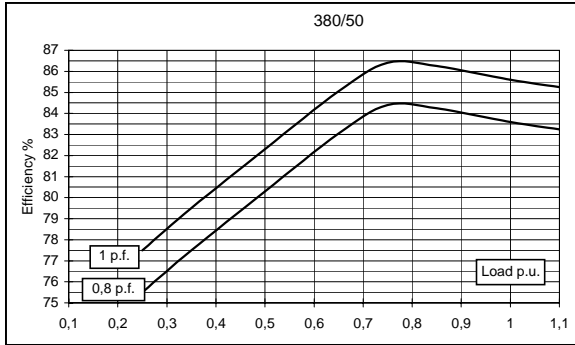
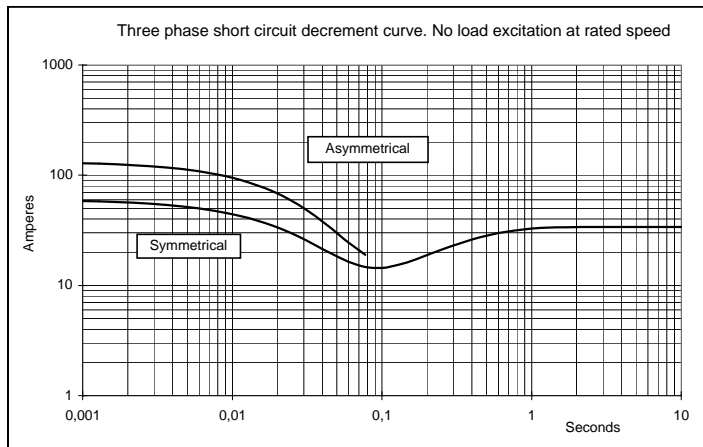
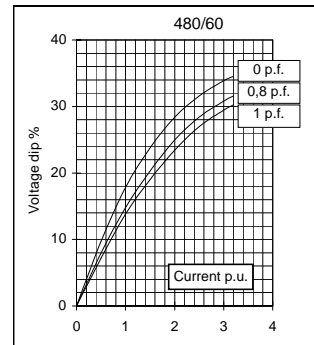
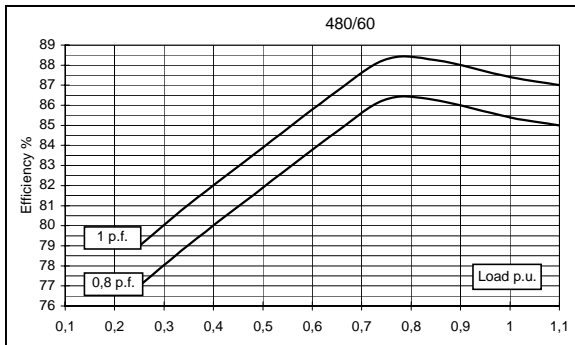
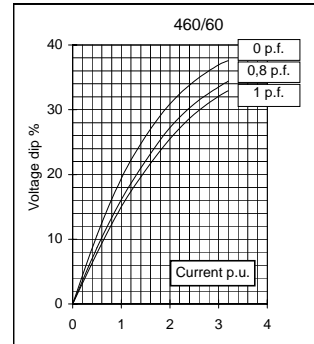
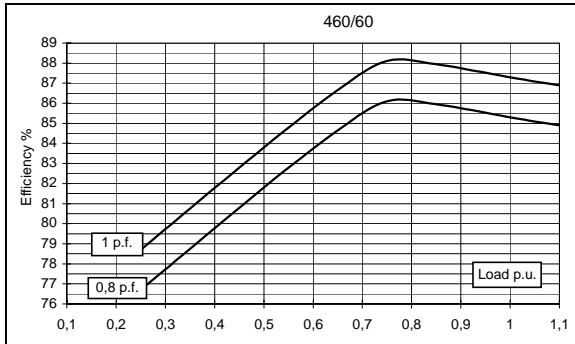
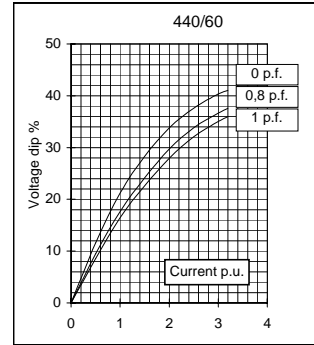
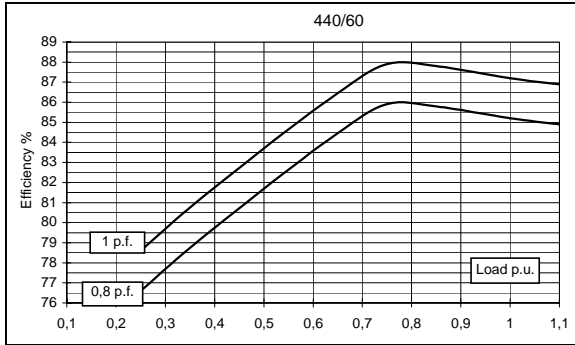
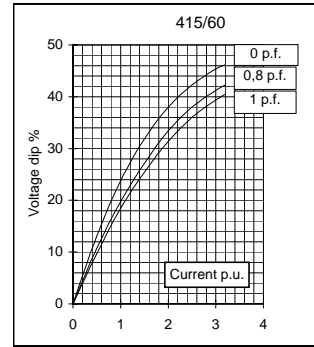
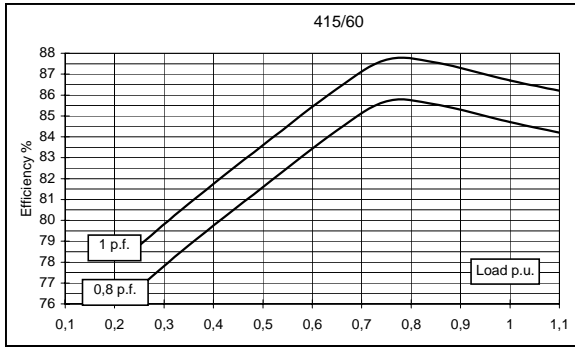

All technical data are to be considered as a reference and they can be modified without any notice
This document is a propriety of Mecc Alte S.p.a.. All rights reserved.

TWO BEARING MOMENTS OF INERTIA

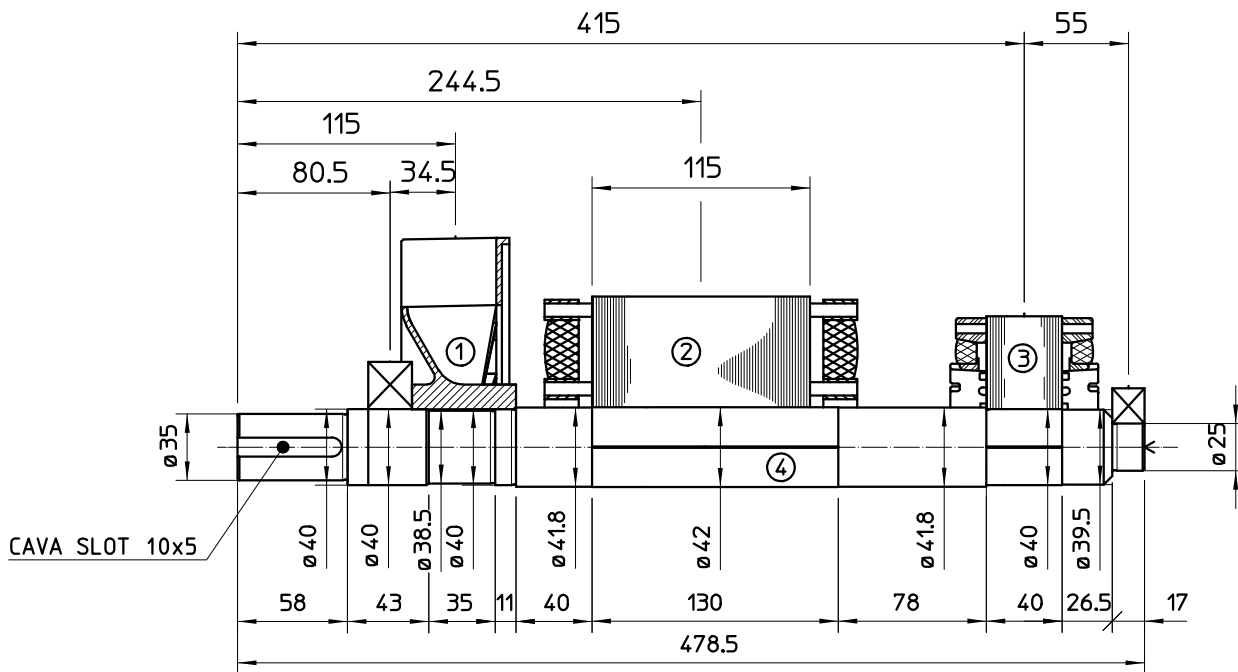

COMPONENT	WEIGHT Kg	J Kgm ²
1 FAN	0.93	0.0036
2 MAIN ROTOR	13.43	0.0472
3 EX ROTOR	4.12	0.011
4 SHAFT	4.7	0.00097
6 TOTAL	23.18	0.06277

TWO BEARING DIMENSIONS

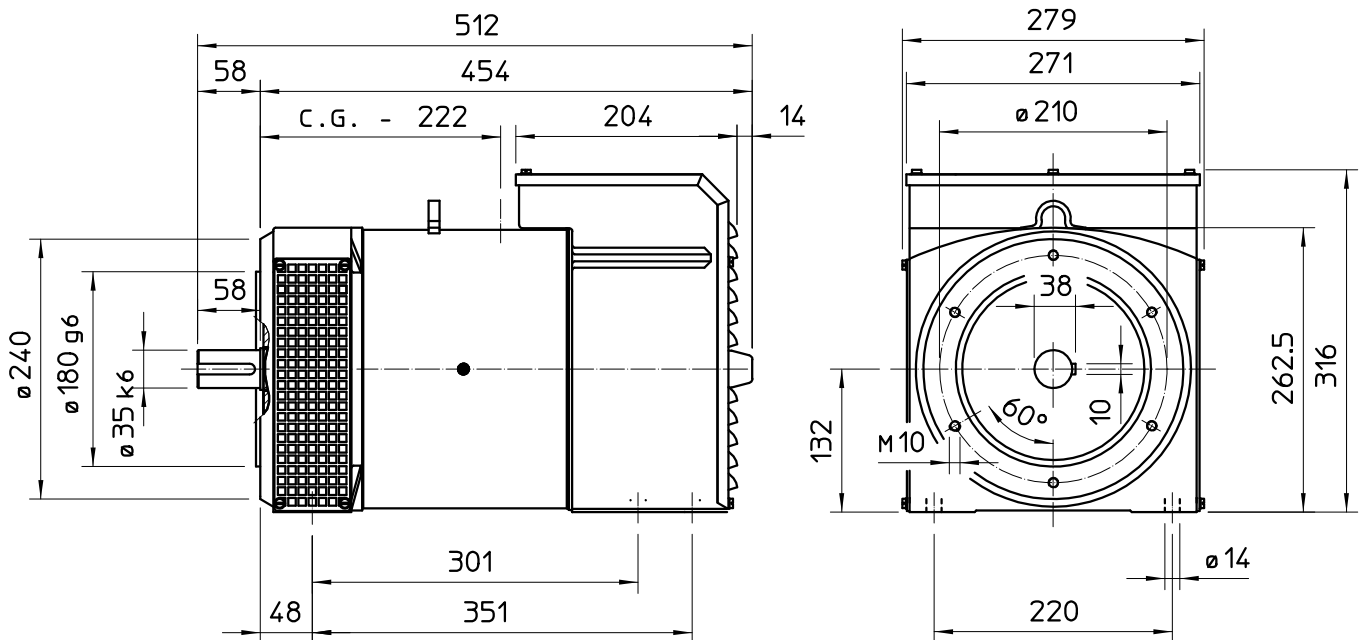

SINGLE BEARING MOMENTS OF INERTIA

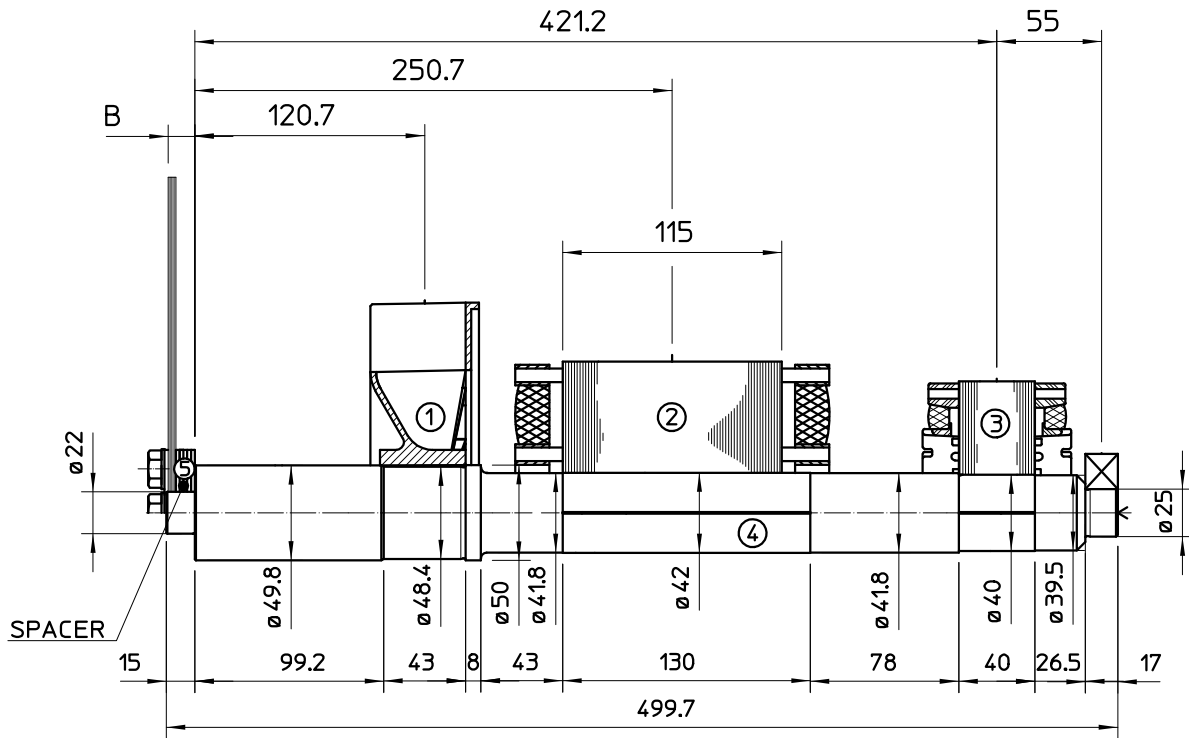

COMPONENT	WEIGHT Kg	J Kg ^m ²
1 FAN	0.82	0.0032
2 MAIN ROTOR	13.43	0.0472
3 EX ROTOR	4.12	0.011
4 SHAFT	5.6	0.0012
TOTAL	23.97	0.0626

SAE N.	5 B (mm)	SHAFT COUPLING FLEX PLATE WEIGHT kg	J kgm ²
6 1/2	4	1.14	0.0067
7 1/2	4	1.42	0.0103
8	35.6	1.97	0.0171
10	27.6	2.59	0.0319
11 1/2	14	3.1	0.0481

SINGLE BEARING DIMENSIONS

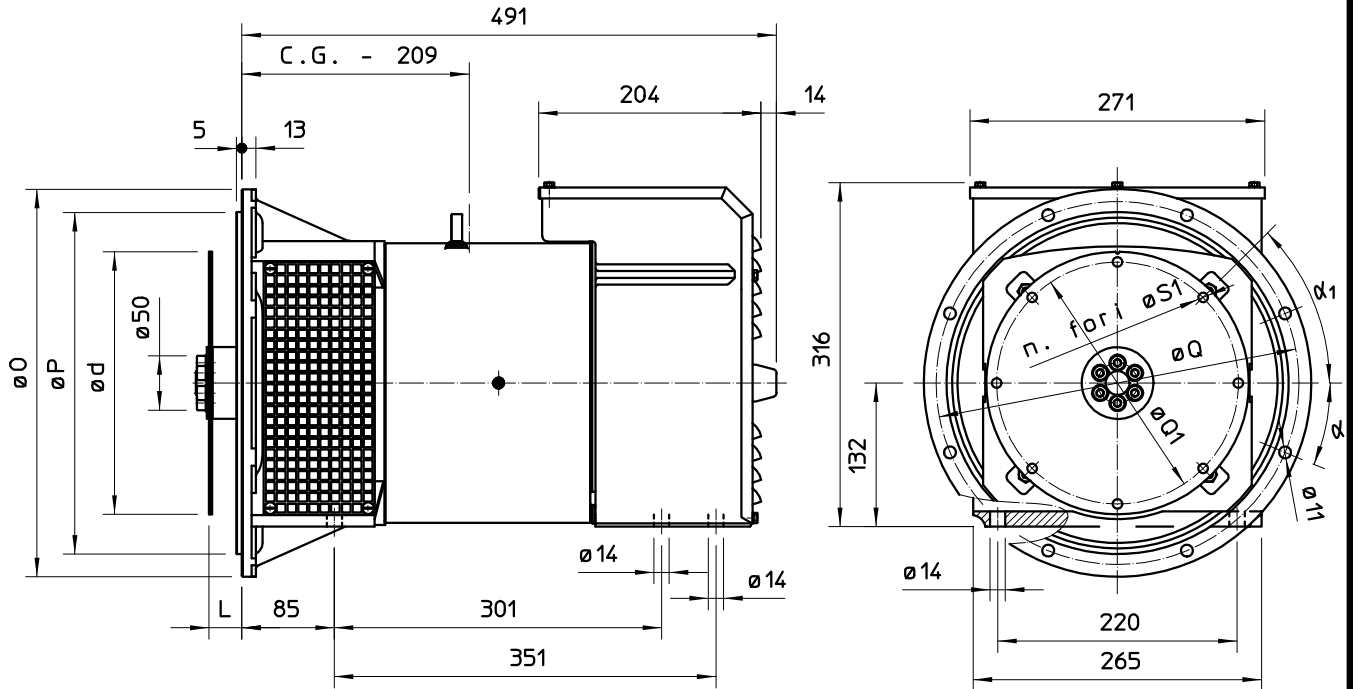

GIUNTI A DISCO COUPLING DISC PLATEX
DISQUE DE MONPALIER SCHEIBENKUPPLUNG
JUNTAS A DISCOS

FLANGIA FLANGE BRIDE FLANSCH BRIDAS	SAE N.	O	P	Q	n. fori	α
	6	308	266.7	285.75	8	22°30'
	5	356	314.3	333.4	8	22°30'
	4	403	362	381	12	15°
	3	451	409.6	428.6	12	15°

SAE N.	L	d	Q1	n. fori	S1	α1
6 1/2	30.2	215.9	200	6	9	60°
7 1/2	30.2	241.3	222.25	8	9	45°
8	62	263.52	244.47	6	11	60°
10	53.8	314.32	295.27	8	11	45°
11 1/2	39.6	352.42	333.37	8	11	45°

C.G. = GRAVITY CENTER