



# GENERATOR TYPE ECP 28-0S/4

Document : **DS176A/1**  
issue 000 date 20/07/2011

Electrical Characteristics										
Frequency	Hz	50				60				
Voltage (series star)	V	380	400	415	440	415	440	460	480	
Rated power class H	kVA	13,5	13,5	13,5	/	14	15	16,2	16,2	
	kW	10,8	10,8	10,8	/	11	12	13	13	
Rated power class F	kVA	12,5	12,5	12,5	/	13	13,5	15	15	
	kW	10	10	10	/	10,4	11	12	12	
Regulation with	DSR	±1% with any power factor and speed variations between -5% +30%								
Insulation class		H								
Execution		Brushless								
Stator winding		12 ends								
Rotor		without damping cage								
Efficiencies class H	4/4	%	86,5	86,6	86,3	/	87	87,5	87,6	87,7
(see graph. for details)	3/4	%	86,6	86,9	86,8	/	87,4	87,6	87,8	88
	2/4	%	84,3	84,4	84,4	/	85,2	85,3	85,4	85,5
	1/4	%	81,6	81,5	81,3	/	82,3	82,1	82,2	82,5
Reactances (f. l.cl. F)	Xd	%	203,9	184	170,9	/	212,7	202,8	200,3	184
	Xd'	%	17,95	16,2	15,05	/	18,73	17,85	17,64	16,2
	Xd''	%	11,52	10,4	9,66	/	12,02	11,46	11,32	10,4
	Xq	%	69,8	63	58,5	/	72,8	69,4	68,6	63
	Xq'	%	69,8	63	58,5	/	72,8	69,4	68,6	63
	Xq''	%	24,4	22	20,4	/	25,4	24,2	24,0	22
	X <sub>2</sub>	%	15,62	14,1	13,10	/	16,30	15,54	15,35	14,1
	X <sub>0</sub>	%	3,43	3,1	2,88	/	3,58	3,42	3,38	3,1
Short Circuit Ratio	Kcc		0,55	0,60	0,66	/	0,41	0,50	0,55	0,60
Time Constants	Td'	sec.	0,06							
	Td''	sec.	0,025							
	Tdo'	sec.	0,98							
	T <sub>α</sub>	sec.	0,019							
Short Circuit Current Capacity		%	>300				>320			
Excitation at no load	Amp.		0,6	0,7	0,8	/	0,4	0,45	0,5	0,6
Excitation at full load	Amp.		2,6	2,7	2,8	/	2,4	2,5	2,6	2,7
Overload (long-term)	%	1 hour in a 6 hours period 110% rated load								
Overload per 20 sec.	%	300								
Stator Winding Resistance (20°C)	Ω	0,43								
Rotor Winding Resistance (20°C)	Ω	1,130								
Exciter Resistance (20 °C)	Ω	Rotor : 0,417				Stator : 10,60				
Heat dissipation at f.l.cl.H	W	1686	1671	1714	/	1674	1714	1835	1818	
Telephone Interference		THF < 2 %				TIF < 45				
Radio interference		EN61000-6-3 EN61000-6-1. For others standards apply to factory								
Waveform Distors.(THD) at f. load	LL/LN %	2 / 2								
Waveform Distors.(THD) at no load	LL/LN %	3,7 / 3,7								
<b>Mechanical characteristics</b>										
Protection		IP 23 (other protection on request)								
DE bearing		6309-2RS								
NDE bearing		6207-2RS								
Weight of wound stator assembly	kg	28,4								
Weight of wound rotor assembly	kg	15,4								
Weight of complete generator	kg	99								
Maximun overspeed	rpm	2250								
Unbalanced magnetic pull at f.l.cl.F	kN/mm	3								
Cooling air requirement	m³/min	5,3				5,8				
Inertia Constant (H)	sec.	0,083				0,099				
Noise level at 1m/7m	dB(A)	68 / 57				71 / 61				

**50 Hz**

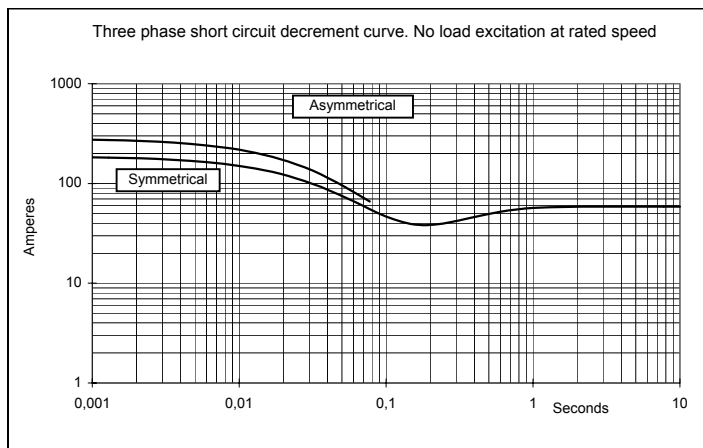
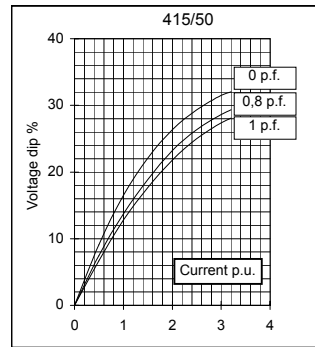
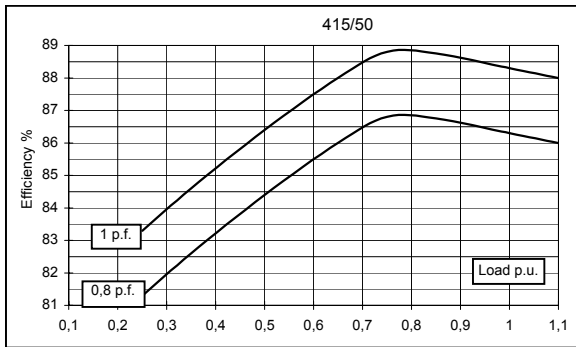
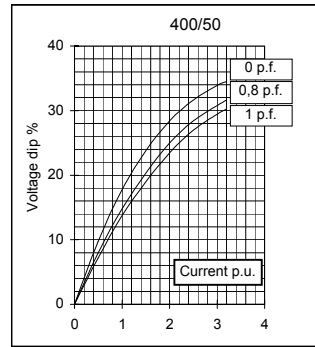
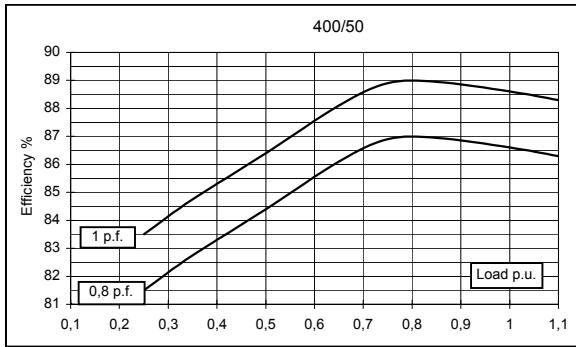
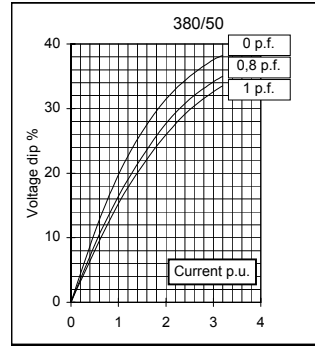
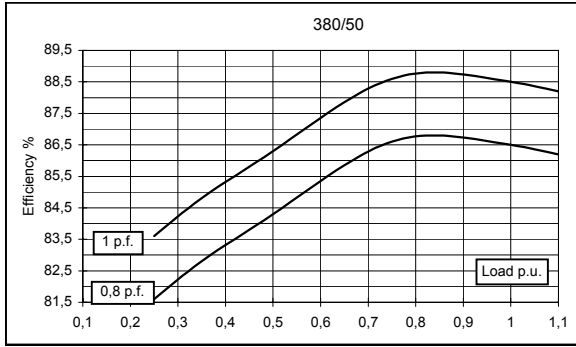

**60 Hz**

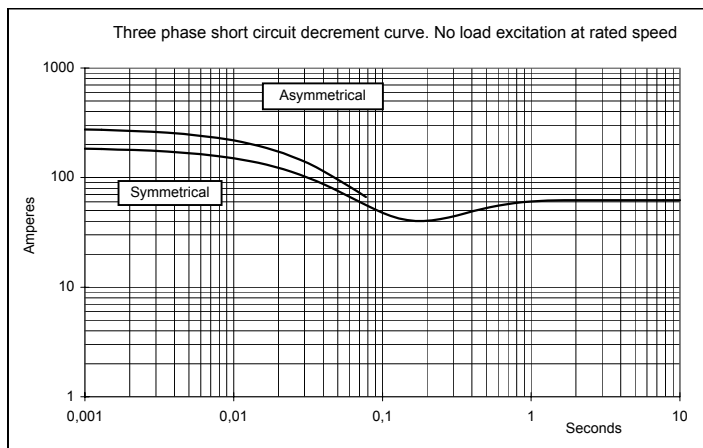
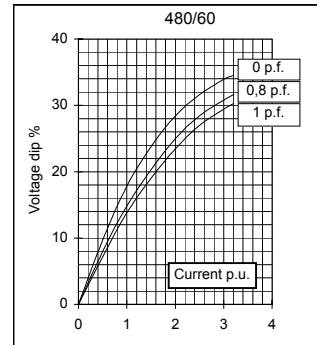
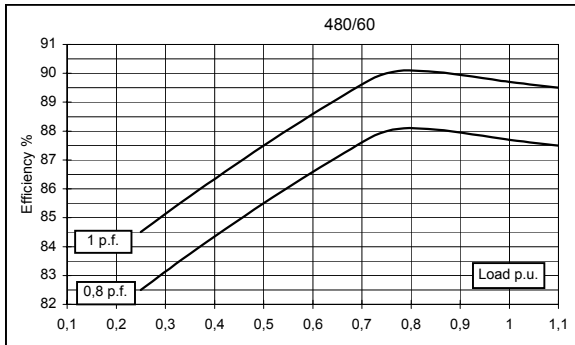
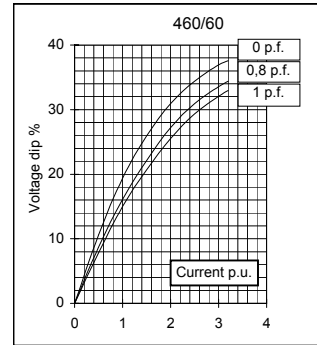
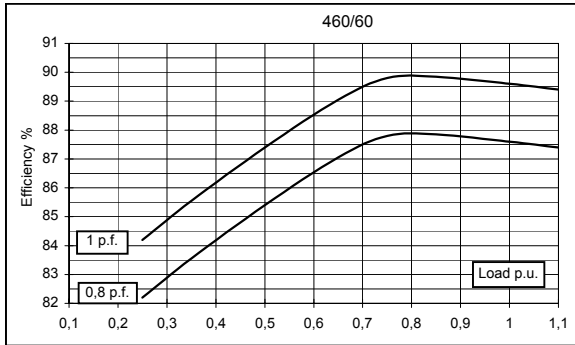
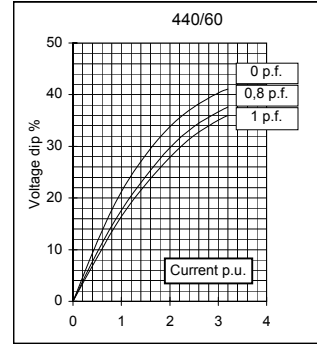
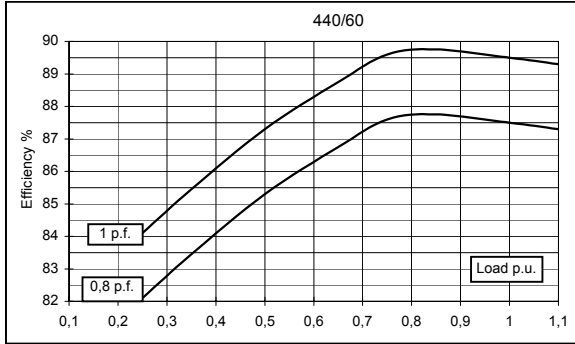
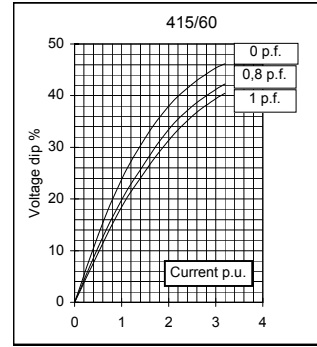
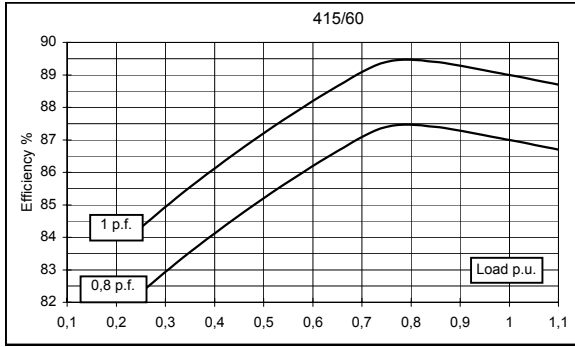



### SINGLE BEARING MOMENTS OF INERTIA

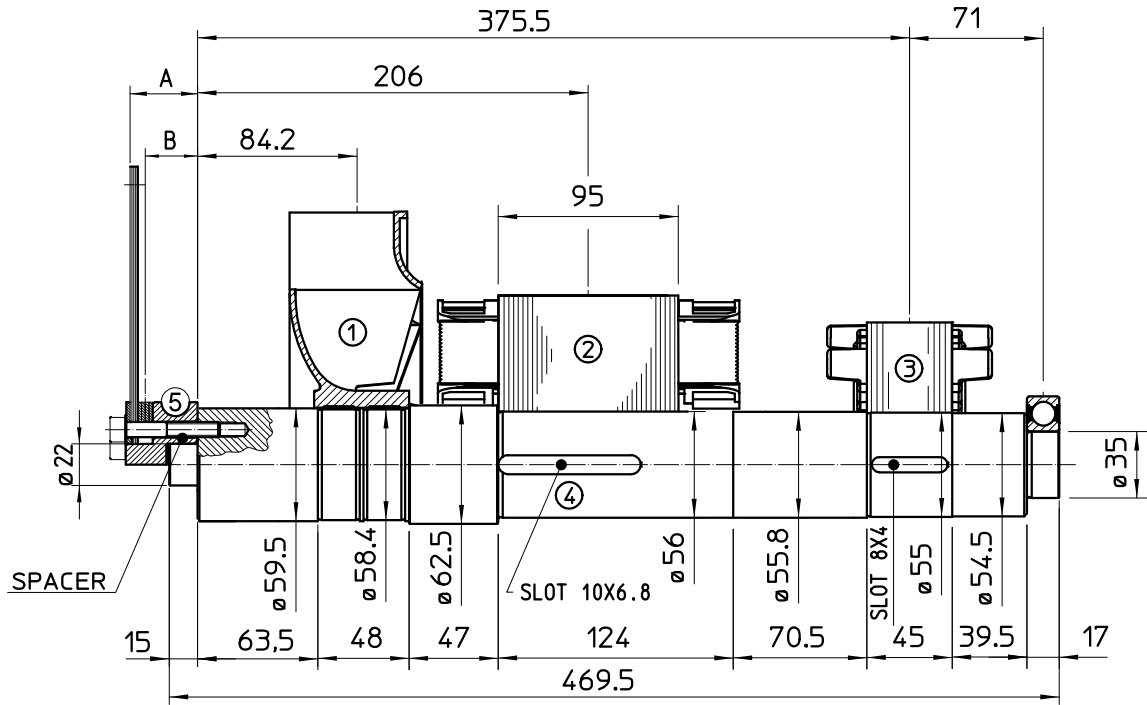

POS.	COMPONENT	WEIGHT (kg)	J (kgm <sup>2</sup> )
1	FAN	1.2	0.0087
2	MAIN ROTOR	15.4	0.061
3	EX. ROTOR	5.5	0.0172
4	SHAFT	8.7	0.0035
TOTAL		30.8	0.0904

SAE N°	SHAFTS COUPLING FLEX PLATE		WEIGHT kg	J kgm <sup>2</sup>
	A	B		
6 1/2	4	2	1.08	0.0065
7 1/2	4	2	1.35	0.0101
8	35.6	28	2.84	0.0158
10	27.6	23	3.2	0.0303
11 1/2	14	11.2	3.6	0.0471

### SINGLE BEARING DIMENSIONS

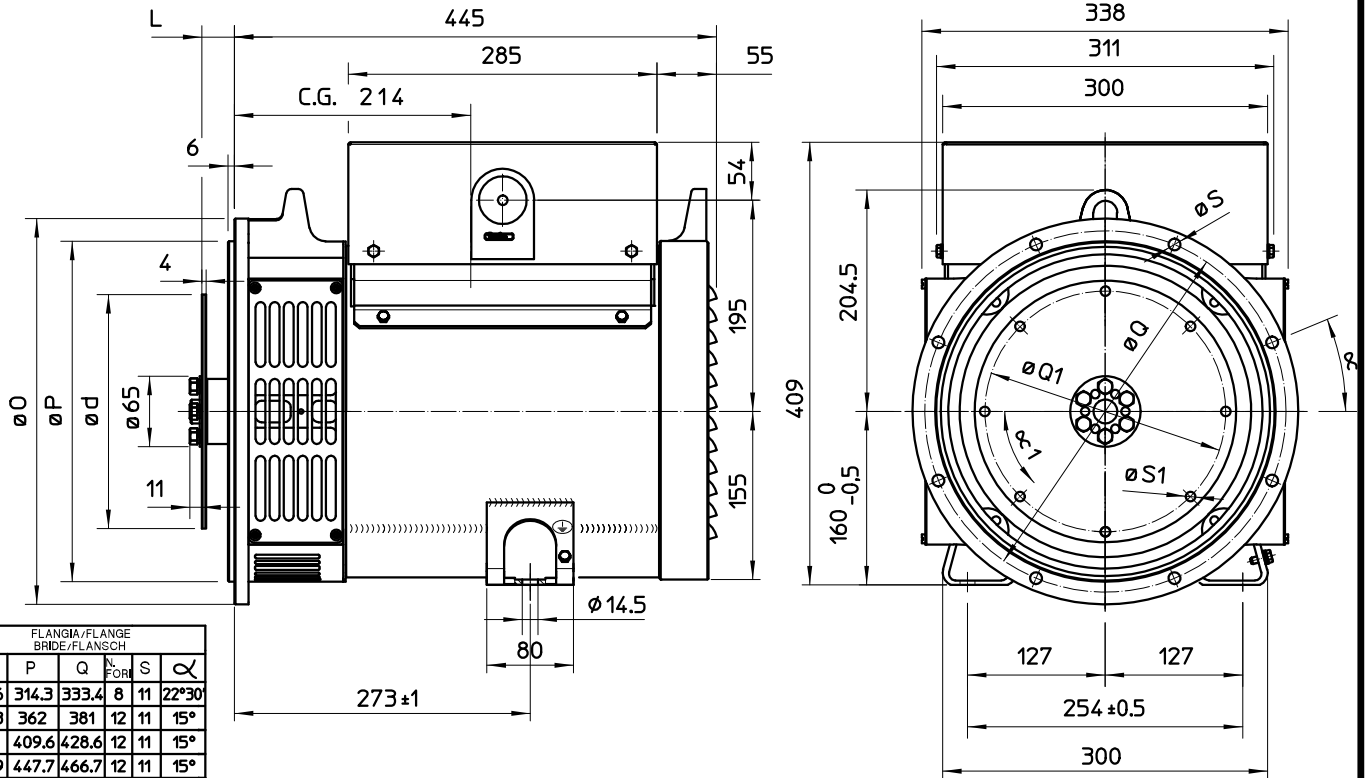

SAE N.	FLANGIA/FLANGE BRIDE/FLANSCH					
	O	P	Q	N FORI	S	α
5	356	314.3	333.4	8	11	22°30'
4	403	362	381	12	11	15°
3	451	409.6	428.6	12	11	15°
2	489	447.7	466.7	12	11	15°

SAE N.	FLANGIA/FLANGE BRIDE/FLANSCH					
	L	d	Q1	N FORI	S1	α <sub>1</sub>
6 1/2	30.2	215.9	200	6	9	60°
7 1/2	30.2	241.3	222.25	8	9	45°
8	62	263.52	244.47	6	11	60°
10	53.8	314.32	295.27	8	11	45°
11 1/2	39.6	352.42	333.37	8	11	45°

C.G.= GRAVITY CENTER