



GENERATOR TYPE ECO 40-1L/4

Document : **DS025A/1**

issue 010 date 21/03/2014

Electrical Characteristics										
Frequency	Hz	50				60				
Voltage (parallel star)	V	380	400	415	440	415	440	460	480	
Rated power class H	kVA	550	550	540	500	570	630	660	660	
	kW	440	440	432	400	456	504	528	528	
Rated power class F	kVA	500	500	490	454	515	570	600	600	
	kW	400	400	392	363	412	456	480	480	
Regulation with	DER1	±1% with any power factor and speed variations between -5% +30%								
Insulation class		H								
Execution		Brushless								
Stator winding		12 ends								
Rotor		with damping cage								
Efficiencies class H	4/4	%	94,7	94,8	94,6	94,4	95,3	95,6	95,7	95,8
(see graph. for details)	3/4	%	94,9	95	94,9	94,5	95,5	95,7	95,8	96
	2/4	%	94	94,1	94	93,8	94,7	94,8	94,9	95,1
	1/4	%	90,5	90,5	90,3	90	91	91,1	91,1	91,3
Reactances (f. l.cl. F)										
	Xd	%	333	238	161	9,1	450	382	333	238
	Xd'	%	20,6	19,4	18,2	17,1	22,7	21,8	20,6	19,4
	Xd''	%	11,5	10,2	9,6	9,2	13,2	12,7	11,5	10,2
	Xq	%	128	112	107	101	149	132	128	112
	Xq'	%	128	112	107	101	149	132	128	112
	Xq''	%	25,2	24,1	22,2	21,5	27,4	26,6	25,2	24,1
	X ₂	%	13,5	12,6	11,4	10,6	15,5	14,2	13,5	12,6
	X ₀	%	3,1	2,8	2,6	2,5	3,4	3,2	3,1	2,8
Short Circuit Ratio	Kcc		0,30	0,42	0,62	1,10	0,22	0,26	0,30	0,42
Time Constants	Td'	sec.	0,14							
	Td''	sec.	0,021							
	Tdo'	sec.	2,90							
	Tα	sec.	0,04							
Short Circuit Current Capacity		%	>300				>350			
Excitation at no load	Amp.		0,5	0,7	1,1	1,3	0,4	0,5	0,6	0,7
Excitation at full load	Amp.		3,2	3,3	3,6	3,8	2,9	3	3,1	3,2
Overload (long-term)	%	1 hour in a 6 hours period 110% rated load								
Overload per 20 sec.	%	300								
Stator Winding Resistance (20°C)	Ω	0,010								
Rotor Winding Resistance (20°C)	Ω	6,025								
Exciter Resistance (20 °C)	Ω	Rotor : 0,317				Stator : 8,85				
Heat dissipation at f.l.cl.H	W	24625	24135	24660	23729	22489	23197	23724	23148	
Telephone Interference		THF < 2%				TIF < 40				
Radio interference		EN61000-6-3, EN61000-6-2. For others standards apply to factory								
Waveform Distors.(THD) at f. load	LL/LN %	2,3 / 2,4								
Waveform Distors.(THD) at no load	LL/LN %	2,5 / 2,5								
Mechanical characteristics										
Protection		IP 21 (other protection on request)								
DE bearing		6322								
NDE bearing		6318.2RS								
Weight of wound stator assembly	kg	477								
Weight of wound rotor assembly	kg	297,5								
Weight of complete generator	kg	1324								
Maximun overspeed	rpm	2250								
Unbalanced magnetic pull at f.l.cl.F	kN/mm	6,1								
Cooling air requirement	m³/min	54				64,8				
Inertia Constant (H)	sec.	0,170				0,204				
Noise level at 1m/7m	dB(A)	94 / 82				98 / 88				

All technical data are to be considered as a reference and they can be modified without any notice.

This document is a propriety of Mecc Alte S.p.A.. All rights reserved.

50 Hz

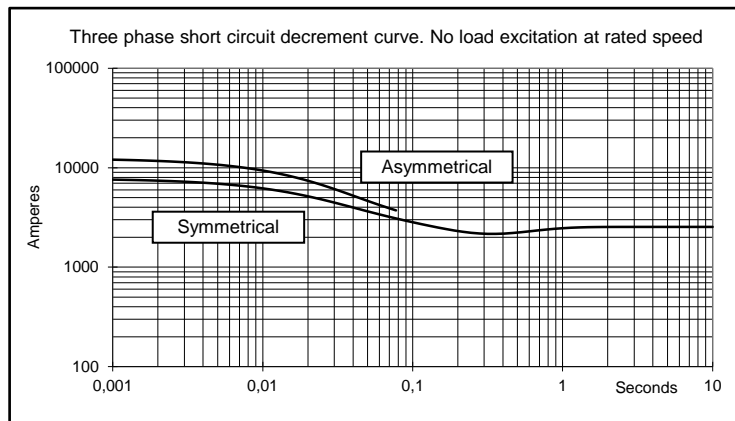
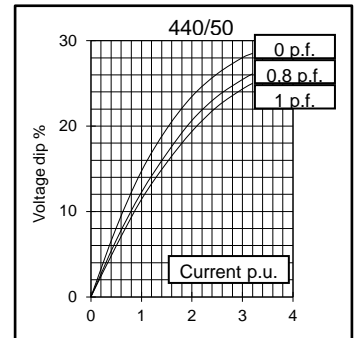
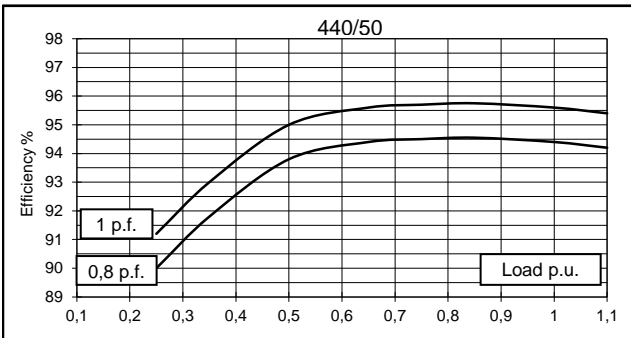
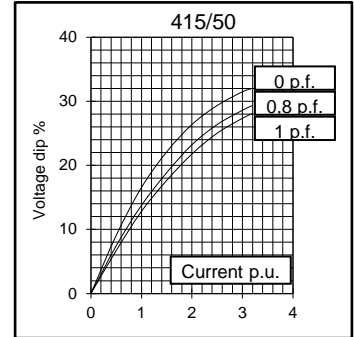
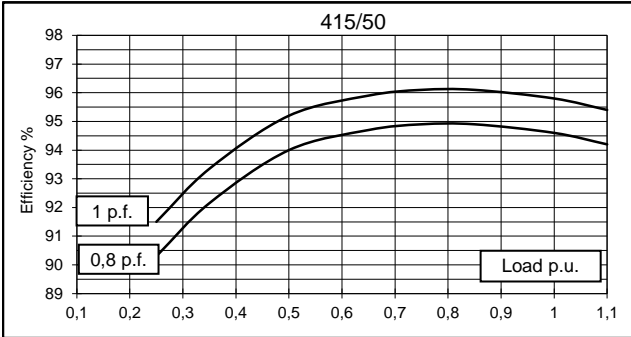
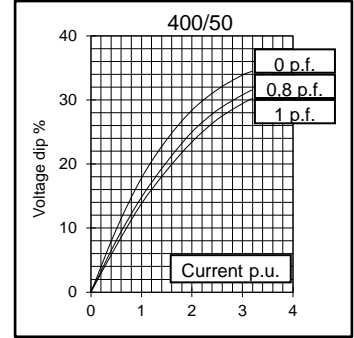
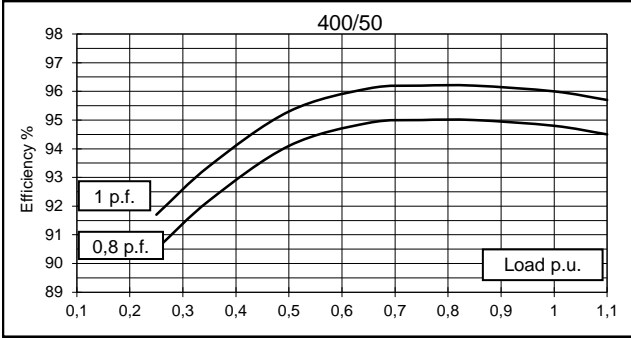
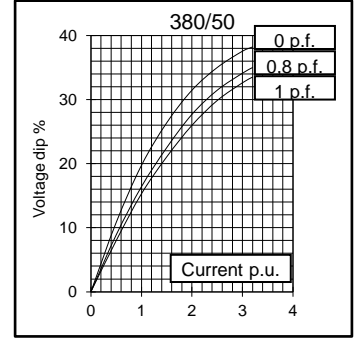
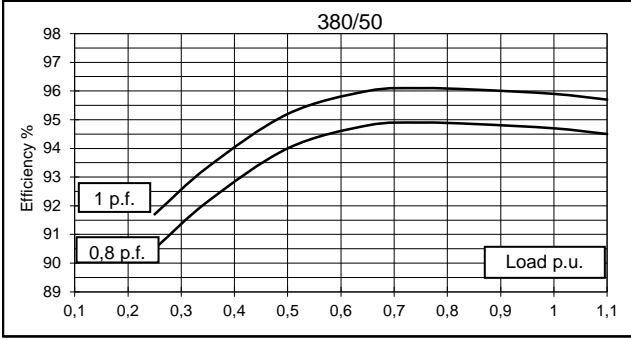



GENERATOR TYPE ECO 40-1L/4

Document : DS025A/3
 issue 009 date : 21/03/2014

60 Hz

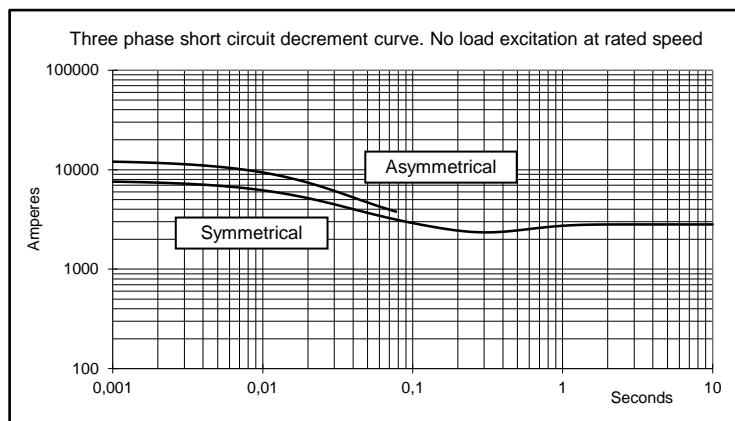
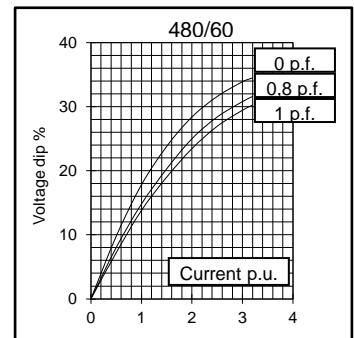
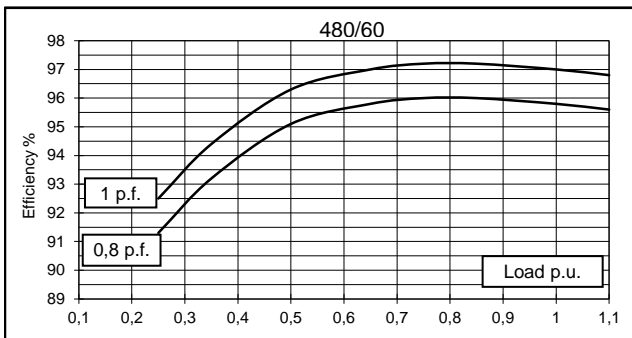
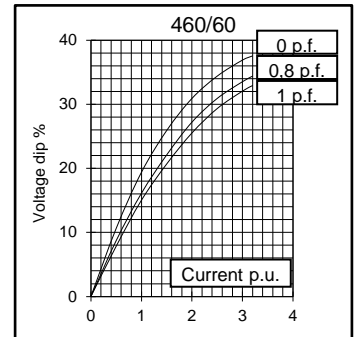
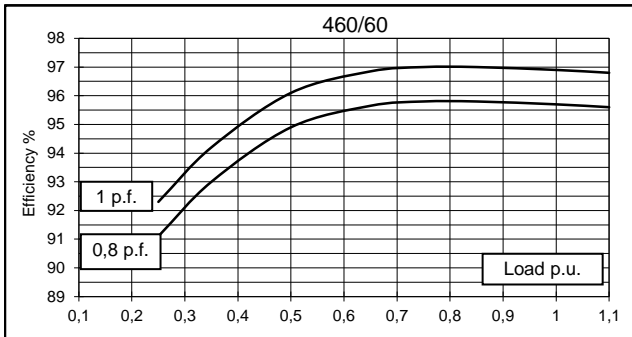
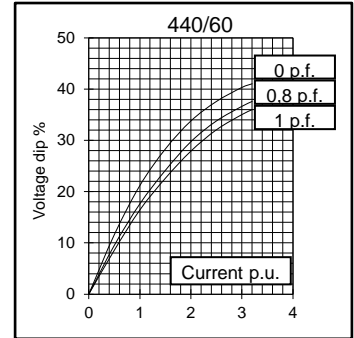
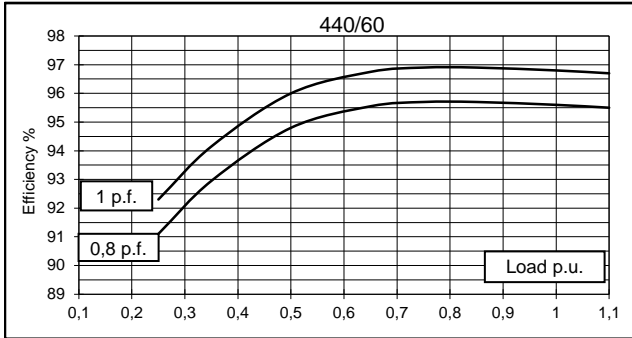
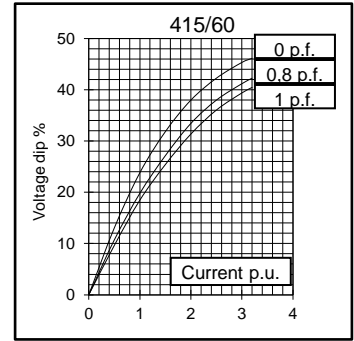
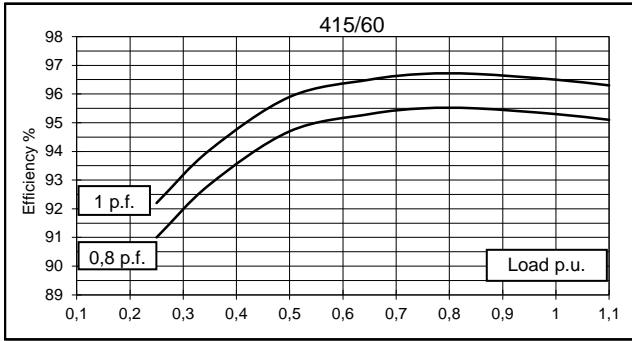

TWO BEARING MOMENTS OF INERTIA

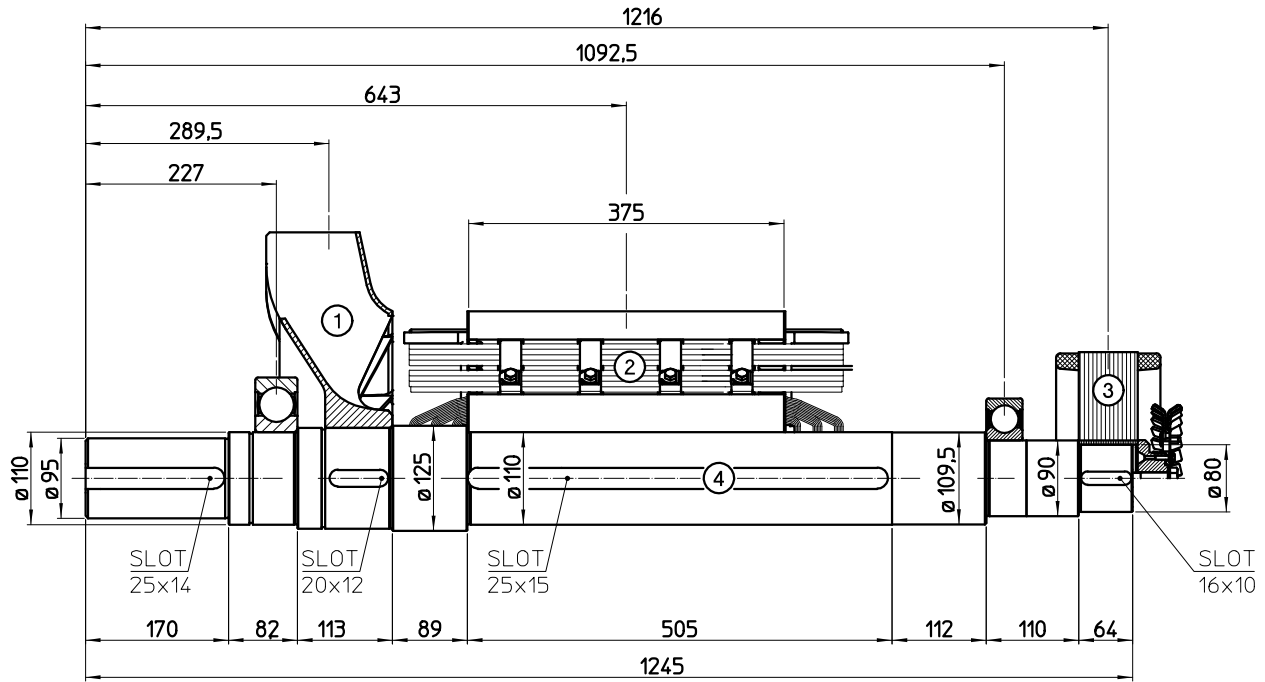

COMPONENT	WEIGHT kg	J kgm ²
1 FAN	10,2	0,335
2 MAIN ROTOR	297,5	6,332
3 EX. ROTOR	35	0,562
4 SHAFT	85,7	0,127
TOTAL	428,4	7,356

TWO BEARING DIMENSIONS

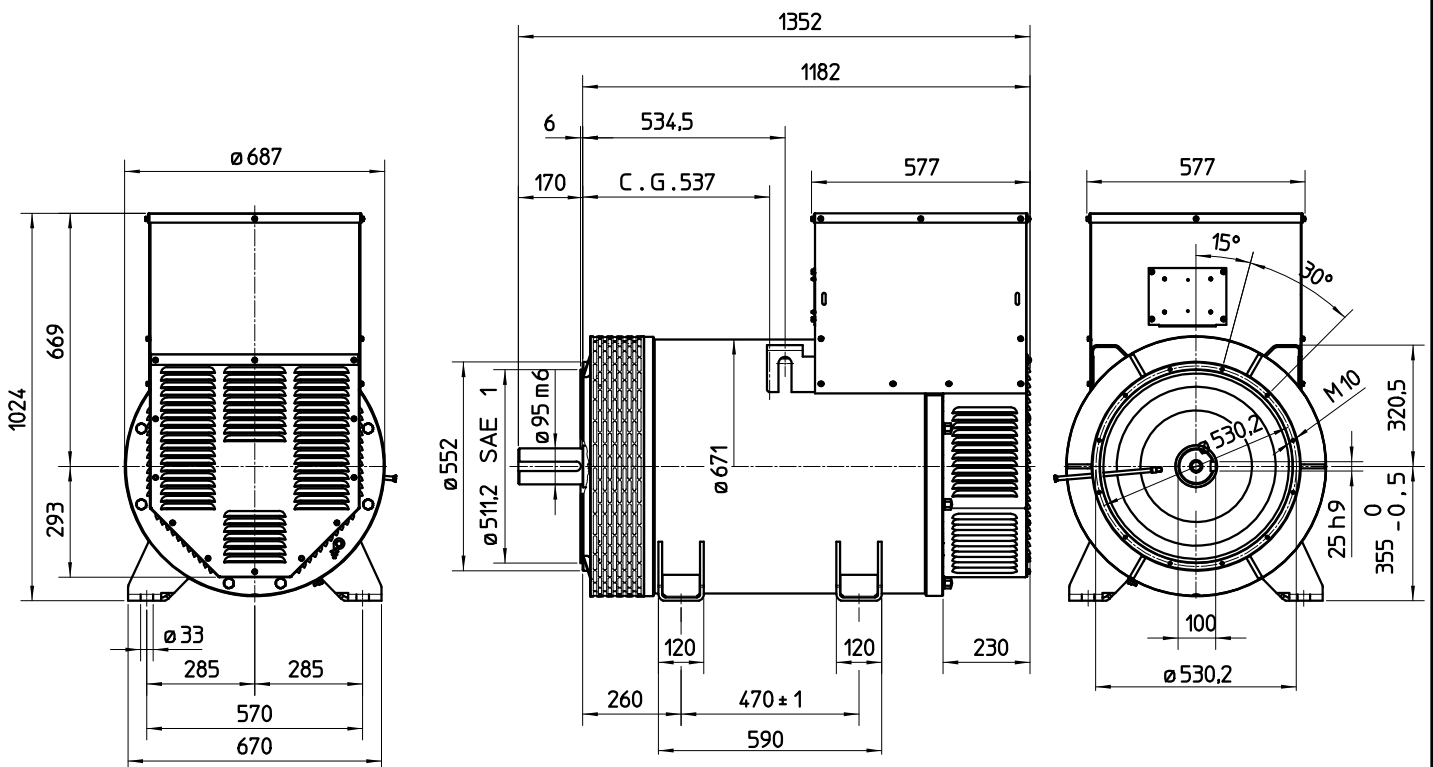

C.G.= GRAVITY CENTER

SINGLE BEARING MOMENTS OF INERTIA

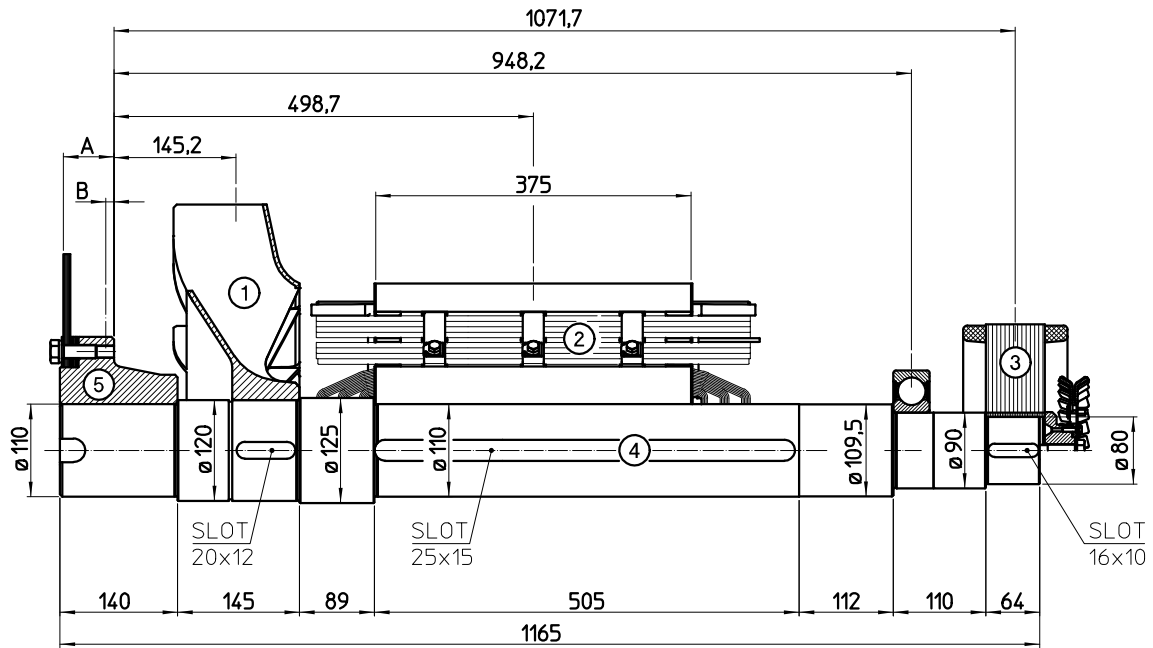

COMPONENT	WEIGHT kg	J kgm ²
1 FAN	10,2	0,335
2 MAIN ROTOR	297,5	6,332
3 EX. ROTOR	35	0,562
4 SHAFT	84,2	0,129
TOTAL	426,9	7,358

Sae No	SHAFTS COUPLING FLEX PLATE			
	A	B	WEIGHT kg	J kgm ²
14	60	9,6	41,4	0,511
18	50	6,6	45,1	0,858

SINGLE BEARING DIMENSIONS

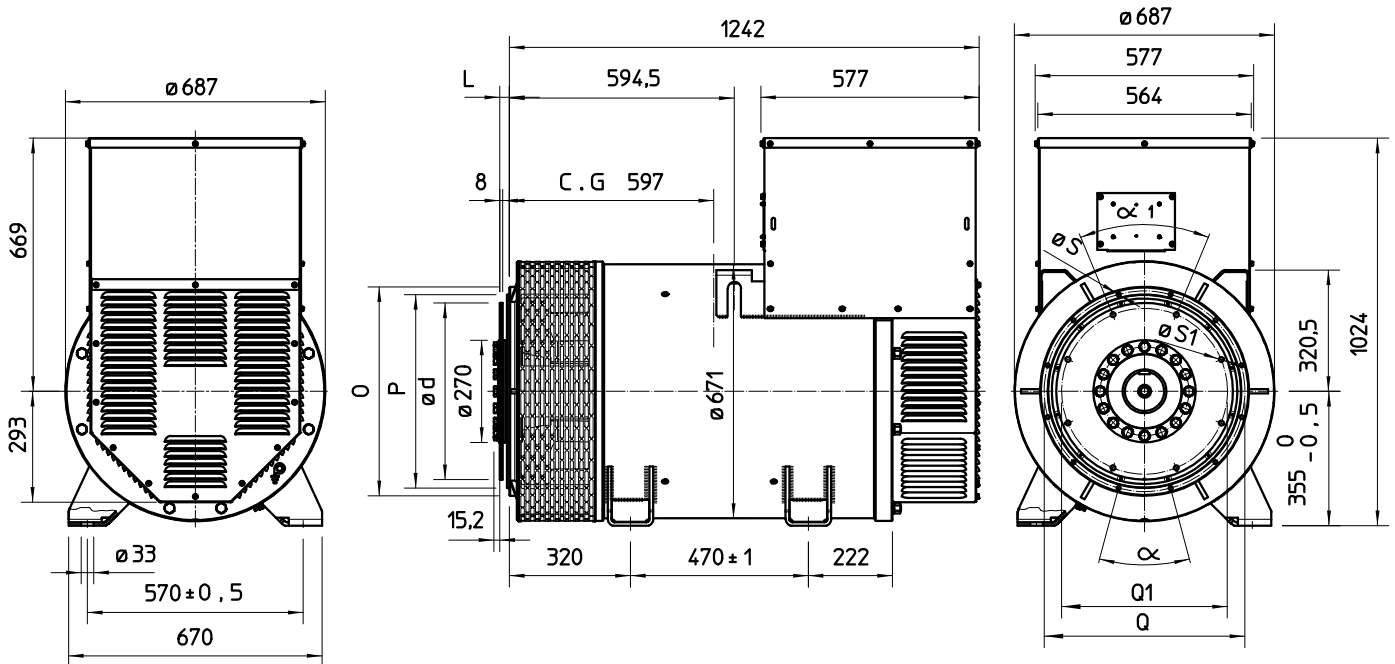

SAE N.	FLANGIA / FLANGE BRIDE / FLANSCH					
	O	P	Q	N. FORI	S	α
1	552	511,2	530,2	12	11	30°
1/2	648	584,2	619,1	12	14	30°
0	711	647,7	679,5	16	14	22,5°
00	883	787,4	850,9	16	14	22,5°

VOL. N.	GIUNTI A DISCHI / DISC COUPLING DISQUE DE MONOPALIER / SCHEIBENKUPPLUNG					
	L	d	Q1	N. FORI	S1	α1
14	25,4	466,72	438,15	8	14	45°
18	15,7	571,5	542,92	6	17	60°

C.G.= GRAVITY CENTER