

Electrical Characteristics										
Frequency	Hz	50				60				
Voltage (parallel star)	V	380	400	415	440	415	440	460	480	
Rated power class H	kVA	930	930	930	840	1020	1060	1116	1116	
	kW	744	744	744	672	816	848	893	893	
Rated power class F	kVA	850	850	850	770	935	969	1020	1020	
	kW	680	680	680	616,0	748	775	816	816	
Regulation with	DSR	±1% with any power factor and speed variations between -5% +30%								
Insulation class		H								
Execution		Brushless								
Stator winding		12 ends								
Rotor		with damping cage								
Efficiencies class H	4/4	%	95,5	95,4	95,2	95	95,2	95,7	95,9	95,8
(see graph. for details)	3/4	%	95,8	95,7	95,5	95,6	95,4	95,6	96	95,8
	2/4	%	94,5	94,4	94,3	94,1	94,5	94,6	94,8	94,7
	1/4	%	92	92	91,8	91,3	93	93	93	93
Reactances (f. l.cl. F)	Xd	%	414,4	374	347,5	280,0	458,6	422,8	407,2	374
	Xd'	%	18,3	16,54	15,4	12,4	20,3	18,7	18,01	16,54
	Xd''	%	8,7	7,81	7,3	5,8	9,6	8,8	8,5	7,81
	Xq	%	170,6	154	143,1	115,3	188,9	174,1	167,7	154
	Xq'	%	170,6	154	143,1	115,3	188,9	174,1	167,7	154
	Xq''	%	21,5	19,38	18	14,5	23,8	21,9	21,1	19,38
	X ₂	%	15,1	13,6	12,6	10,2	16,7	15,4	14,8	13,6
	X ₀	%	4,1	3,7	3,4	2,8	4,5	4,2	4,03	3,7
Short Circuit Ratio	Kcc		0,28	0,33	0,38	0,48	0,19	0,23	0,28	0,33
Time Constants	Td'	sec.	0,234							
	Td''	sec.	0,0169							
	Tdo'	sec.	8,30							
	Tα	sec.	0,0223							
Short Circuit Current Capacity		%	>300				>350			
Excitation at no load	Amp.		0,5	0,6	0,8	0,9	0,3	0,4	0,5	0,6
Excitation at full load	Amp.		2,5	2,8	3	3,2	2,3	2,4	2,5	2,8
Overload (long-term)		%	1 hour in a 6 hours period 110% rated load							
Overload per 20 sec.		%	300							
Stator Winding Resistance (20°C)	Ω		0,0086							
Rotor Winding Resistance (20°C)	Ω		2,300							
Exciter Resistance (20 °C)	Ω		Rotor : 0,130				Stator : 10,63			
Heat dissipation at f.l.cl.H	W		35058	35874	37513	35368	41143	38102	38170	39142
Telephone Interference			THF < 2%				TIF < 40			
Radio interference			EN61000-6-3, EN61000-6-1. For others standards apply to factory							
Waveform Distors.(THD) at f. load	LL/LN %		2 / 2,3							
Waveform Distors.(THD) at no load	LL/LN %		2,7 / 2,9							
Mechanical characteristics										
Protection			IP 21 (other protection on request)							
DE bearing			6324							
NDE bearing			6322							
Weight of wound stator assembly	kg		731							
Weight of wound rotor assembly	kg		551							
Weight of complete generator	kg		2090							
Maximun overspeed	rpm		2250							
Unbalanced magnetic pull at f.l.cl.F	kN/mm		5,7							
Cooling air requirement	m ³ /min		90				108			
Inertia Constant (H)	sec.		0,255				0,306			
Noise level at 1m/7m	dB(A)		95 / 84				99 / 89			

All technical data are to be considered as a reference and they can be modified without any notice.

This document is a propriety of Mecc Alte S.p.A.. All rights reserved.

50 Hz

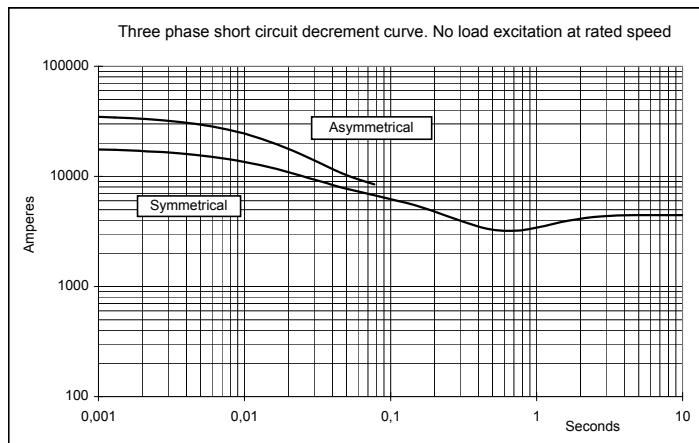
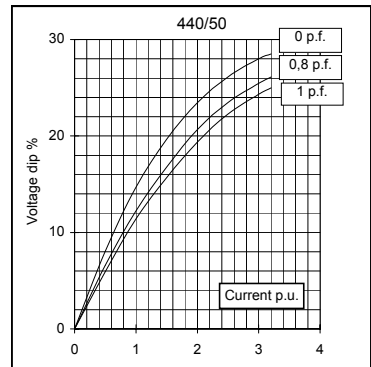
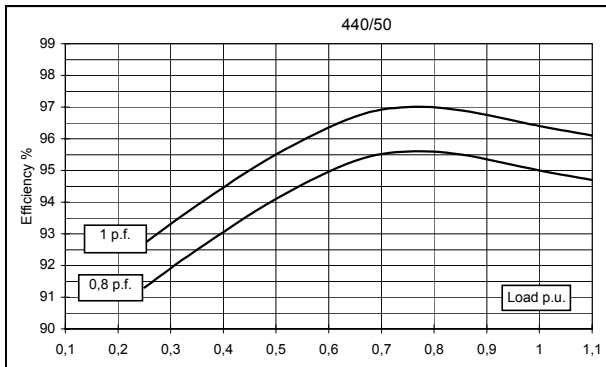
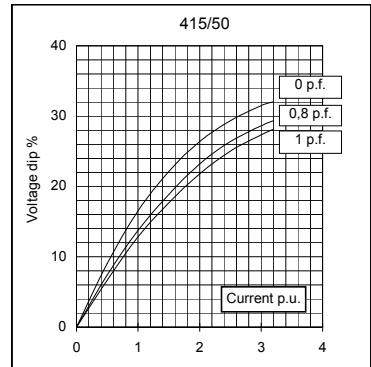
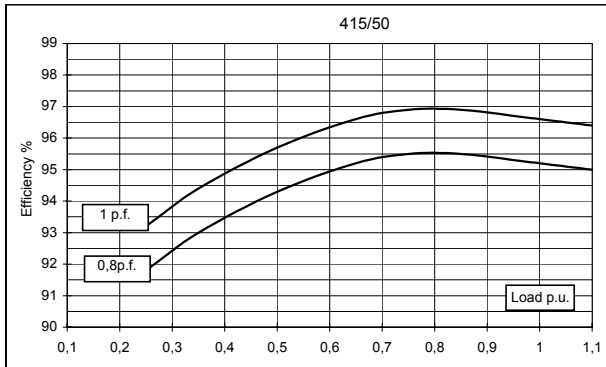
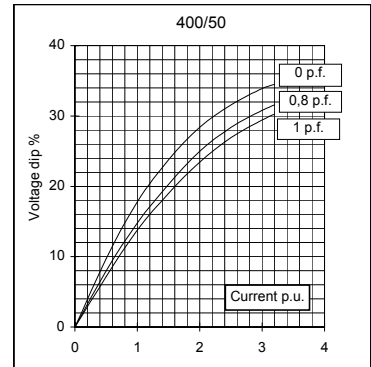
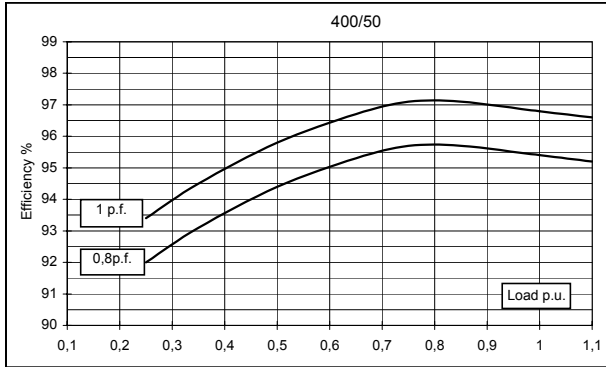
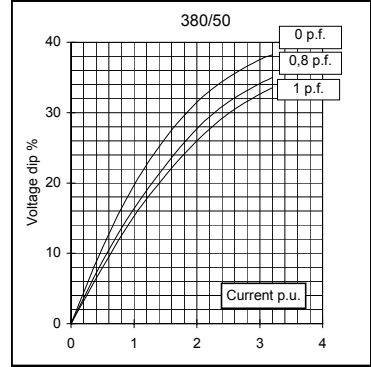
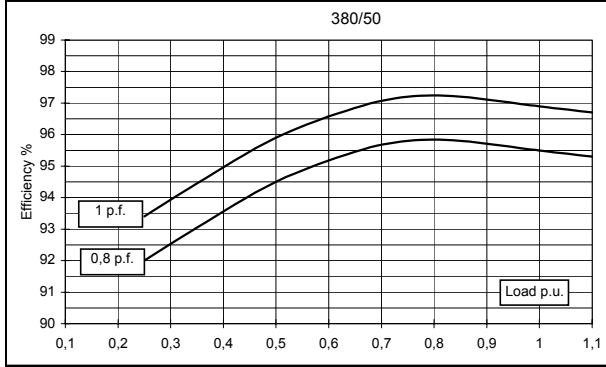

60 Hz

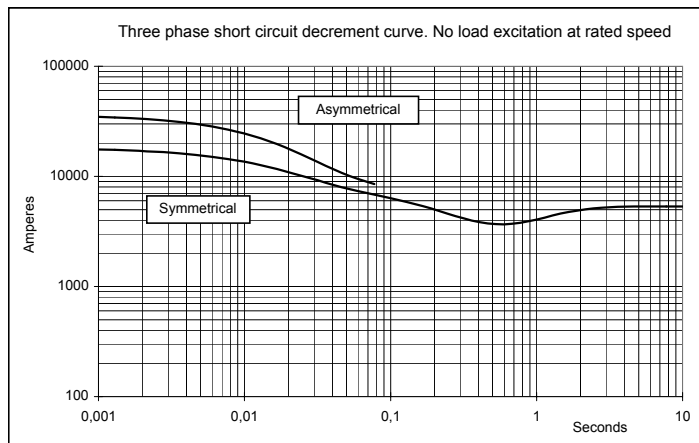
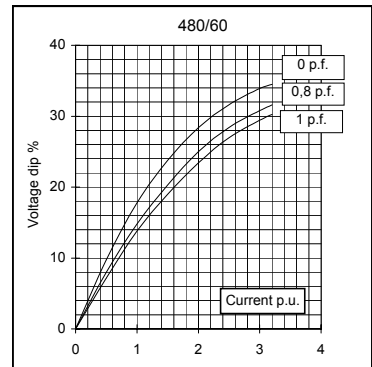
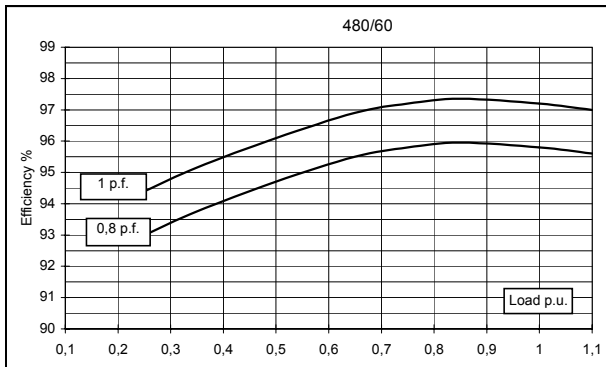
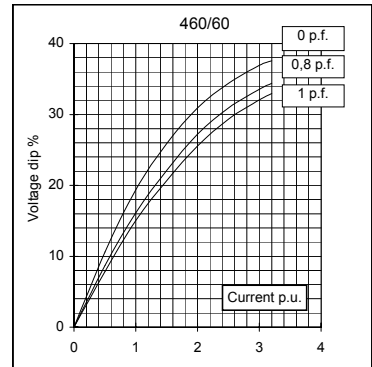
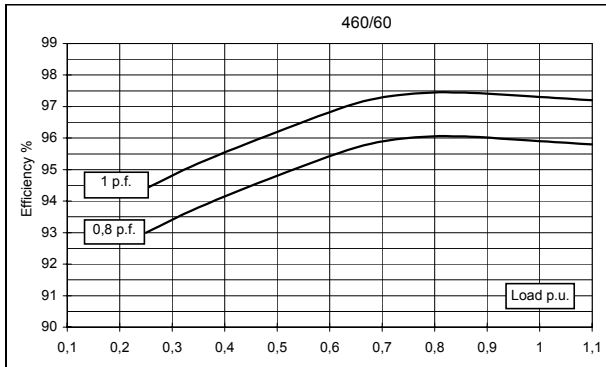
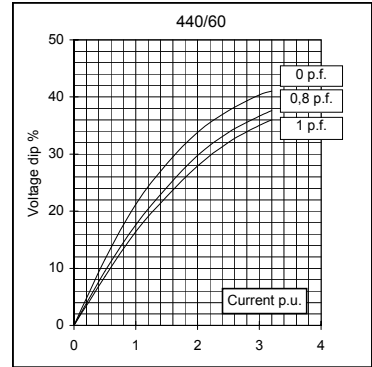
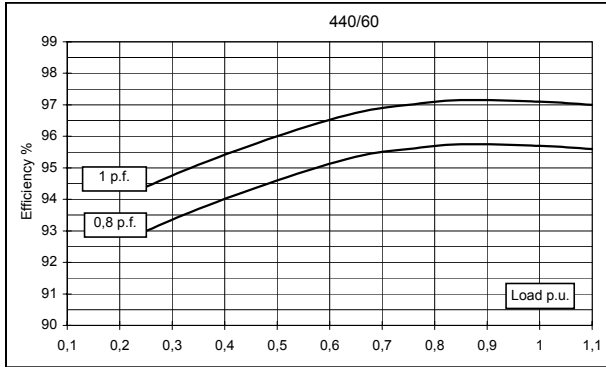
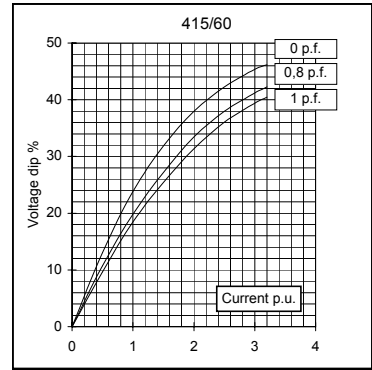
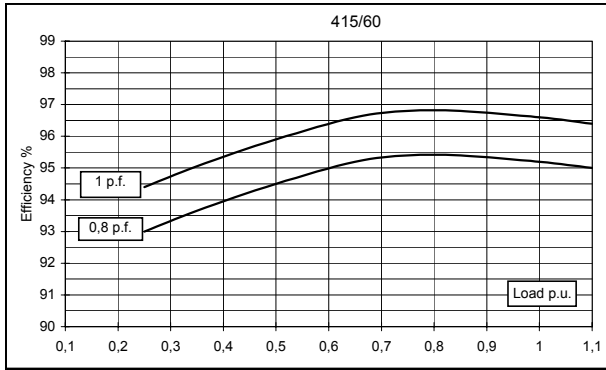

TWO BEARING MOMENTS OF INERTIA

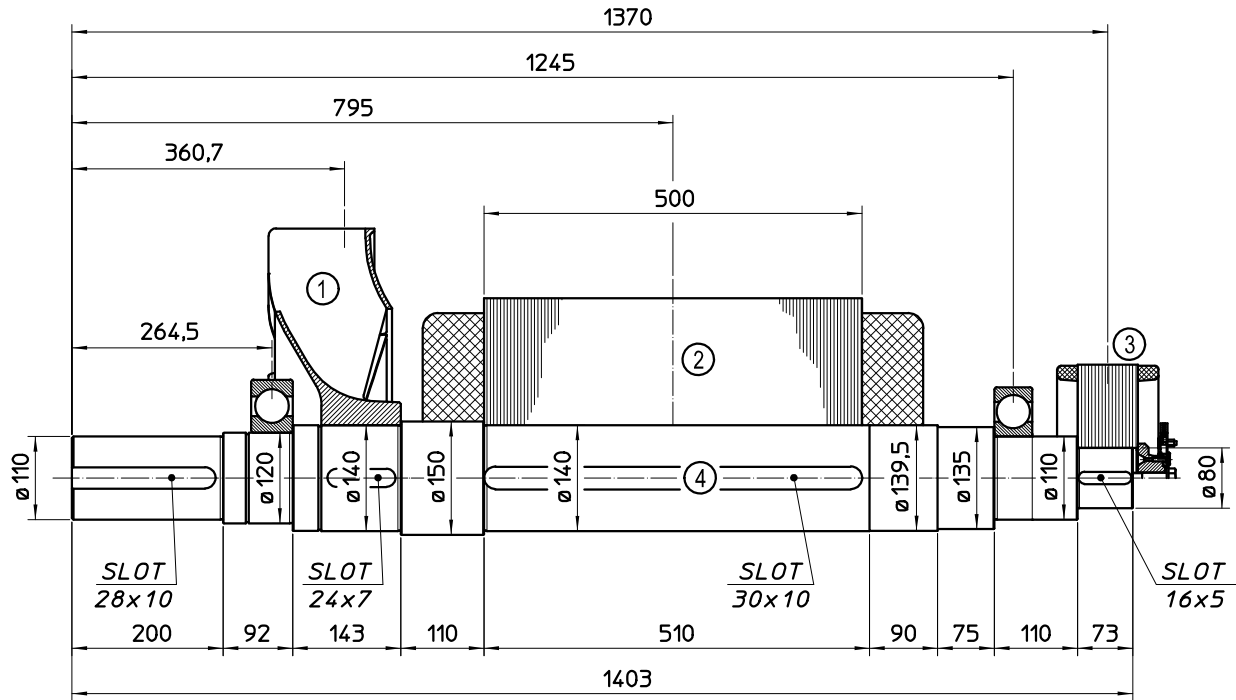

POS.	COMPONENT	WEIGHT (kg)	J (kgm ²)
1	FAN	16.3	0.646
2	MAIN ROTOR	551	16.965
3	EX. ROTOR	40	0.629
4	SHAFT	147.1	0.426
TOTAL		754.4	18.666

TWO BEARING DIMENSIONS

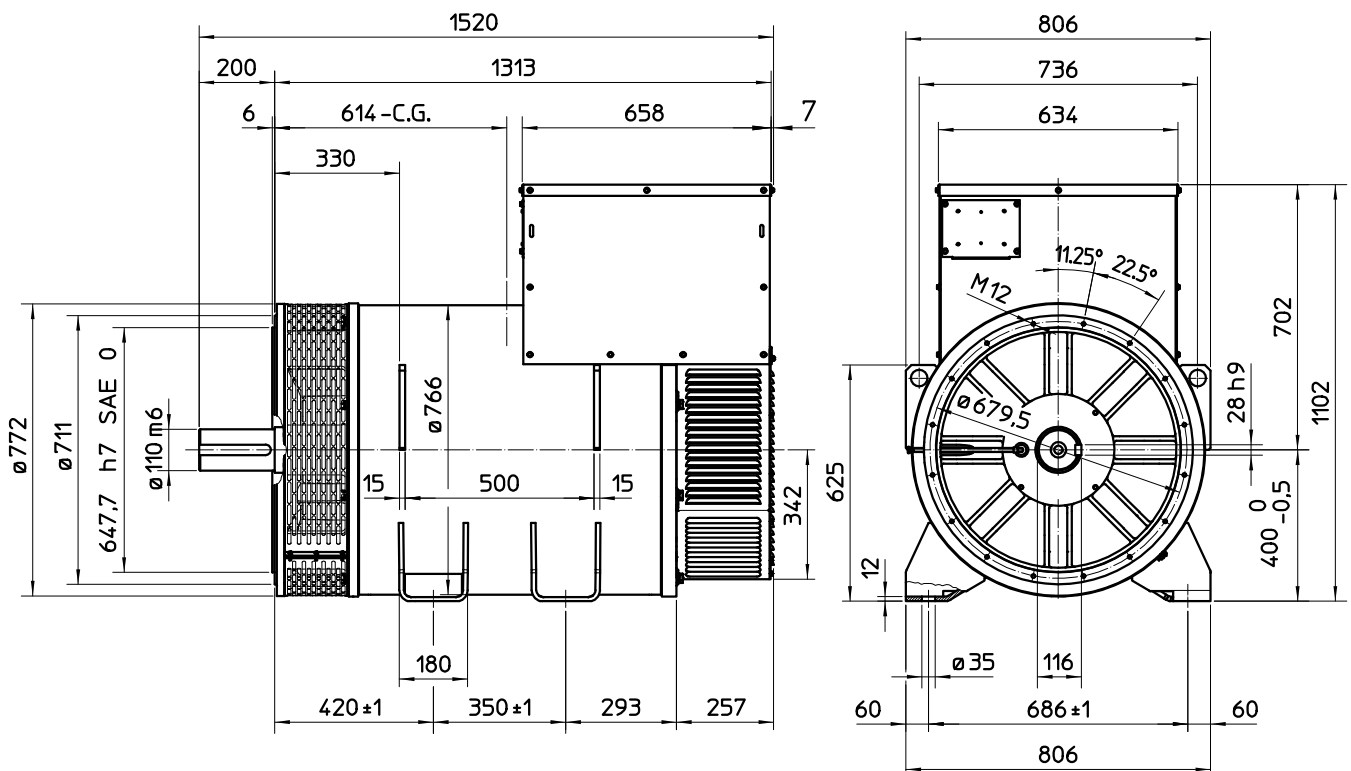

SINGLE BEARING MOMENTS OF INERTIA

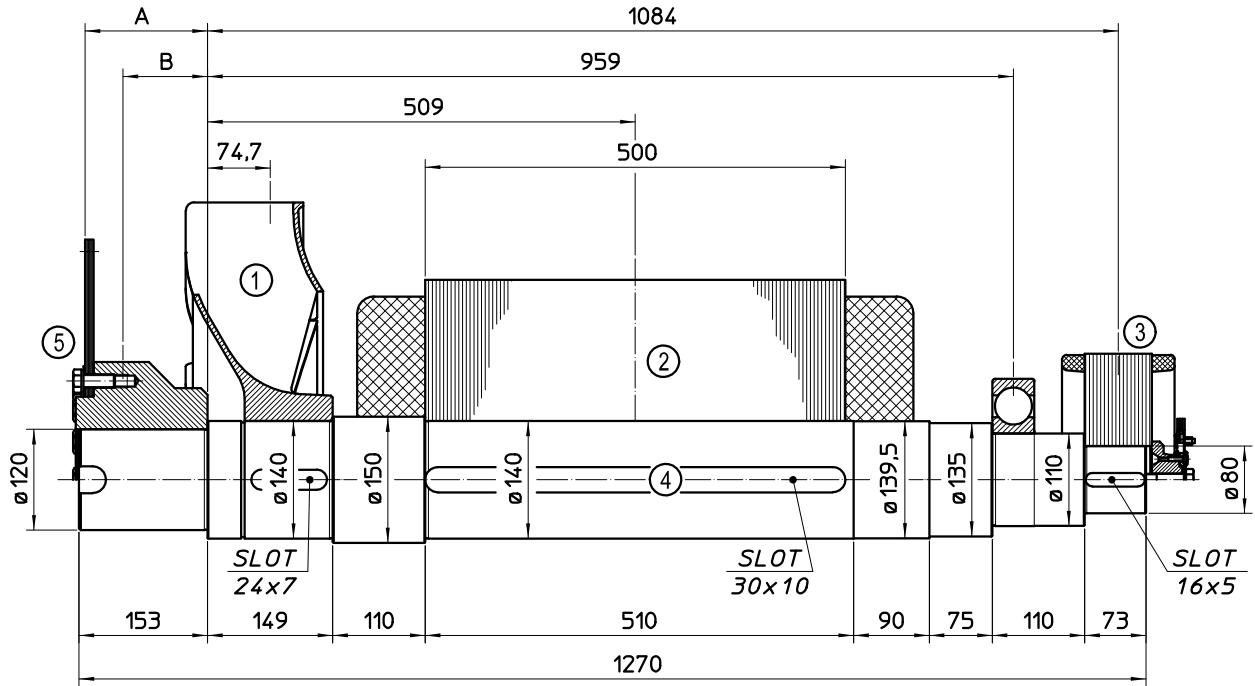

POS.	COMPONENT	WEIGHT (kg)	J (kgm ²)
1	FAN	16.3	0.646
2	MAIN ROTOR	551	16.965
3	EX. ROTOR	40	0.629
4	SHAFT	136	0.314
TOTAL		743.3	18.554

POS.	COMPONENT	SAE N°	A	B	WEIGHT (kg)	J (kgm ²)
5	SHAFTS COUPLING FLEX PLATE	14	155.7	99.5	56.3	0.824
		18	145.7	100.7	60.8	1.244
		21	130	98.5	68.9	2.231

SINGLE BEARING DIMENSIONS

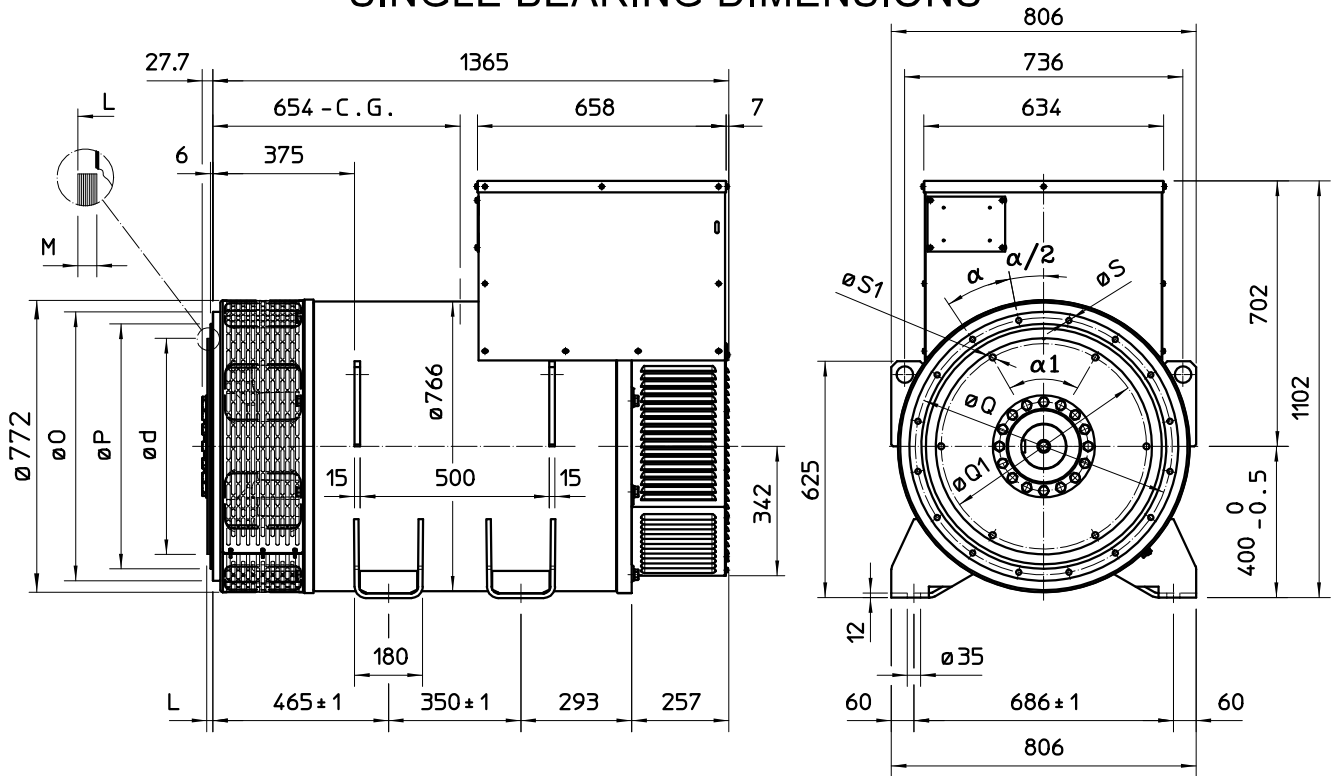

SAE N°	FLANGE					
	O	P	Q	S	HOLES N°	α
1	711	511.2	530.2	12	12	30
0	711	647.7	679.5	14	16	22.5
00	883	787.4	850.9	14	16	22.5

SAE N°	DISC COUPLING						
	d	L	M	Q1	S1	HOLES N°	$\alpha 1$
14	466.72	25.4	10	438.15	13.5	8	45
18	571.5	15.7	10	542.92	16.5	6	60°
21	673.1	0	12	641.35	16.5	12	30°

C.G.= GRAVITY CENTER