



GENERATOR TYPE ECP 3-3L/4

Document : **DS152A/1**

issue 002 date 29/04/2014

Electrical Characteristics										
Frequency	Hz	50				60				
Voltage (series star)	V	380	400	415	440	415	440	460	480	
Rated power class H	kVA	15	15	15	12	16	18	18	18	
	kW	12	12	12	9,6	12,8	14,4	14,4	14,4	
Rated power class F	kVA	14	14	14	10,5	13	16,5	16,5	16,5	
	kW	11,2	11,2	11,2	8,4	10,4	13,2	13,2	13,2	
Regulation with	DSR	±1 % with any power factor and speed variations between -5% +30%								
Insulation class		H								
Execution		Brushless								
Stator winding		12 ends								
Rotor		without damping cage								
Efficiencies class H	4/4	%	86,2	86,3	86	85,8	87,5	88	88,1	88,2
(see graph. for details)	3/4	%	86,6	86,9	86,8	86,5	87,8	88	88,2	88,4
	2/4	%	85,3	85,4	85,4	85,1	86,1	86,2	86,3	86,4
	1/4	%	81,8	81,8	81,6	81,1	82,6	82,4	82,5	82,8
Reactances (f. l.cl. F)	Xd	%	155,1	140	130,1	92,6	166,5	166,6	152,4	140
	Xd'	%	15,7	14,2	13,2	9,4	16,9	16,9	15,5	14,2
	Xd''	%	10,9	9,8	9,1	6,5	11,7	11,7	10,7	9,8
	Xq	%	86,4	78	72,5	51,6	92,8	92,8	84,9	78
	Xq'	%	86,4	78	72,5	51,6	92,8	92,8	84,9	78
	Xq''	%	57,6	52	48,3	34,4	61,8	61,9	56,6	52
	X ₂	%	18,9	17,1	15,9	11,3	20,3	20,4	18,6	17,1
	X ₀	%	6	5,4	5	3,6	6,4	6,4	5,9	5,4
Short Circuit Ratio	Kcc		0,80	1,1	1,13	1,5	0,67	0,75	0,80	1,1
Time Constants	Td'	sec.	0,042							
	Td''	sec.	0,0105							
	Tdo'	sec.	0,84							
	Tα	sec.	0,0112							
Short Circuit Current Capacity		%	>300				>320			
Excitation at no load	Amp.		0,3	0,35	0,4	0,47	0,22	0,25	0,3	0,32
Excitation at full load	Amp.		1,1	1,2	1,3	1,4	0,95	1	1,1	1,15
Overload (long-term)		%	1 hour in a 6 hours period 110% rated load							
Overload per 20 sec.		%	300							
Stator Winding Resistance (20°C)	Ω		0,314							
Rotor Winding Resistance (20°C)	Ω		10,884							
Exciter Resistance (20 °C)	Ω		Rotor : 1,453				Stator : 15,71			
Heat dissipation at f.l.cl.H	W		1921	1905	1953	1589	1829	1964	1945	1927
Telephone Interference			THF < 2%				TIF < 45			
Radio interference			EN61000-6-3, EN61000-6-2. For others standards apply to factory							
Waveform Distors.(THD) at f. load	LL/LN %		2,2 / 2,0							
Waveform Distors.(THD) at no load	LL/LN %		2,8 / 2,7							
Mechanical characteristics										
Protection			IP 23 (other protection on request)							
DE bearing			6308-2RS							
NDE bearing			6305-2RS							
Weight of wound stator assembly	kg		28,6							
Weight of wound rotor assembly	kg		24,8							
Weight of complete generator	kg		93							
Maximun overspeed	rpm		2250							
Unbalanced magnetic pull at f.l.cl.F	kN/mm		3							
Cooling air requirement	m³/min		3				3,5			
Inertia Constant (H)	sec.		0,075				0,090			
Noise level at 1m/7m	dB(A)		72 / 58				78 / 60			

All technical data are to be considered as a reference and they can be modified without any notice

This document is a propriety of Mecc Alte S.p.a..All rights reserved.

50 Hz

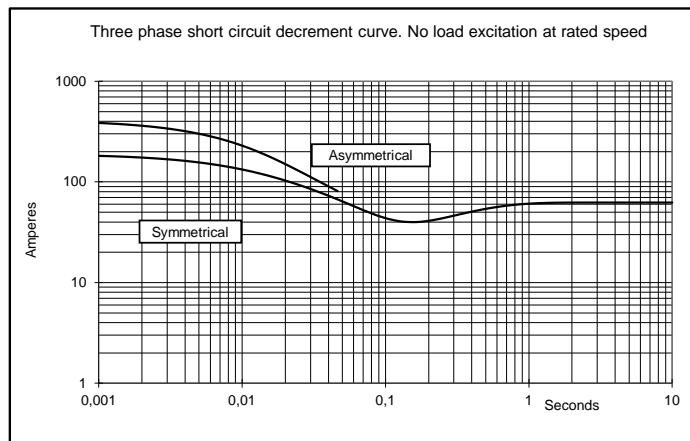
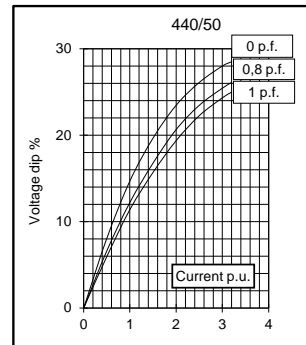
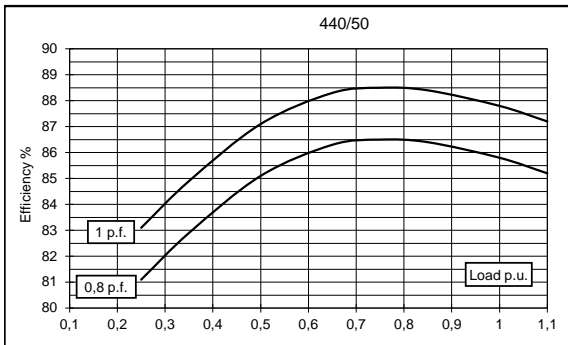
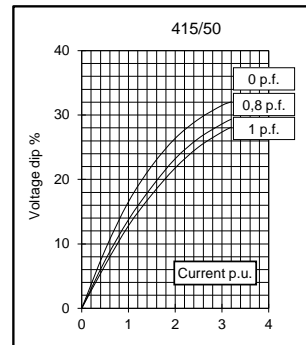
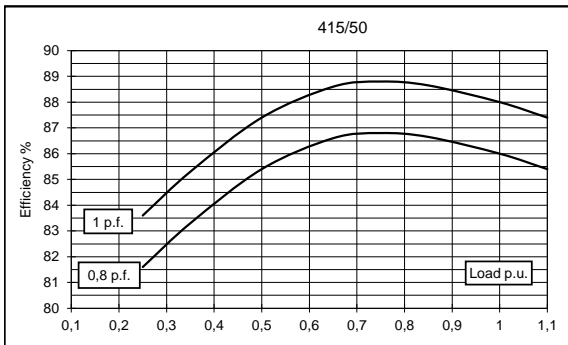
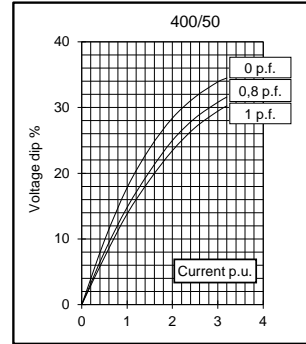
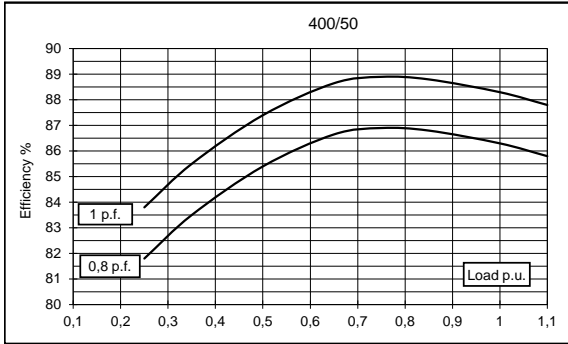
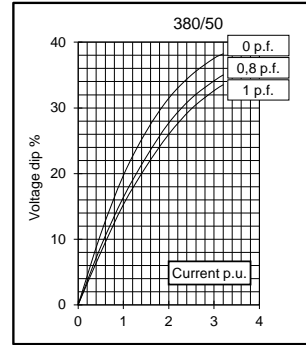
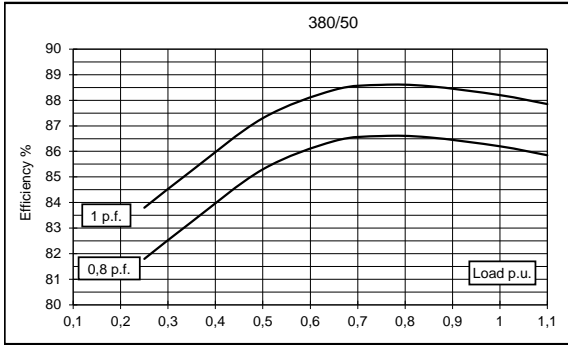

All technical data are to be considered as a reference and they can be modified without any notice
 This document is a propriety of Mecc Alte S.p.a.. All rights reserved.

60 Hz

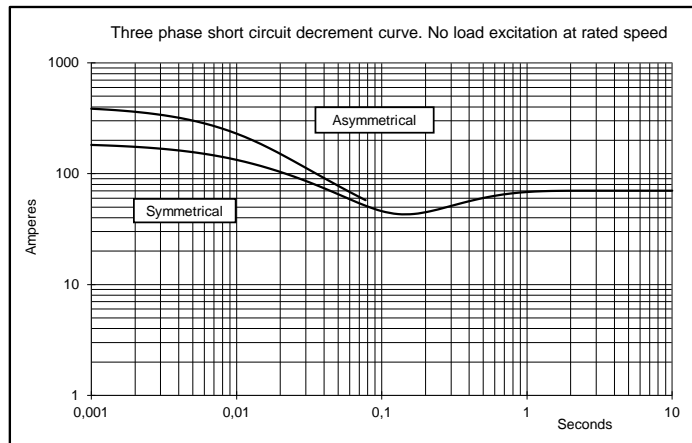
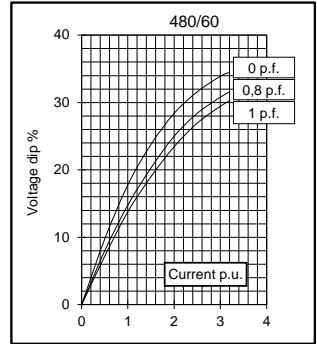
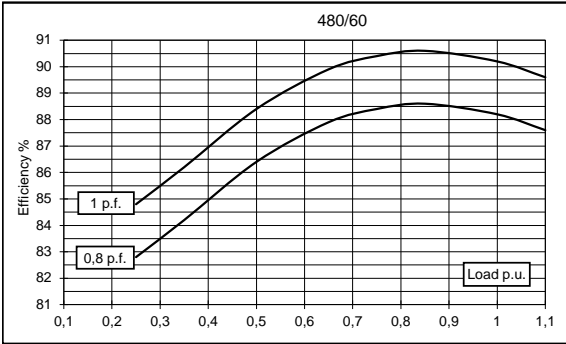
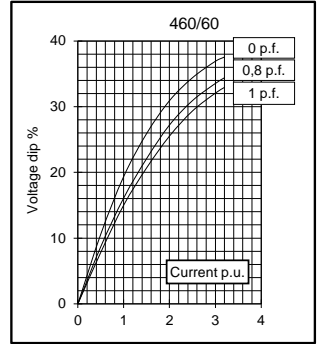
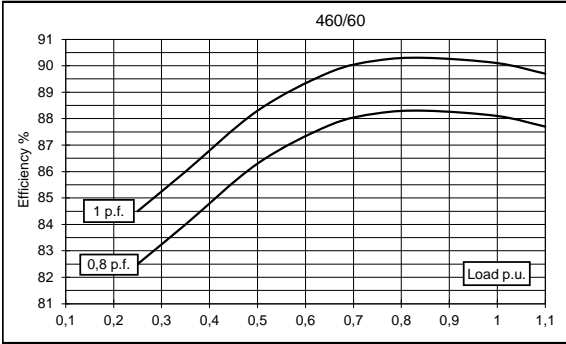
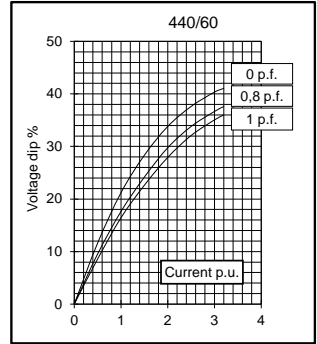
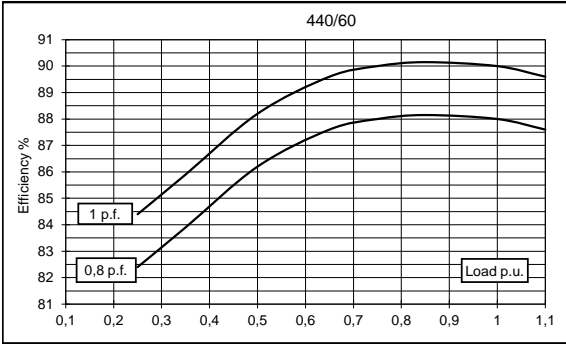
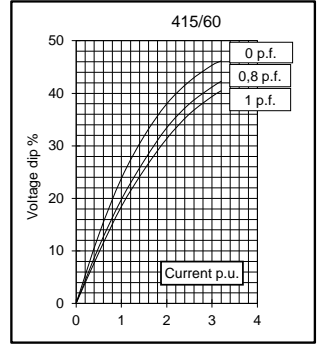
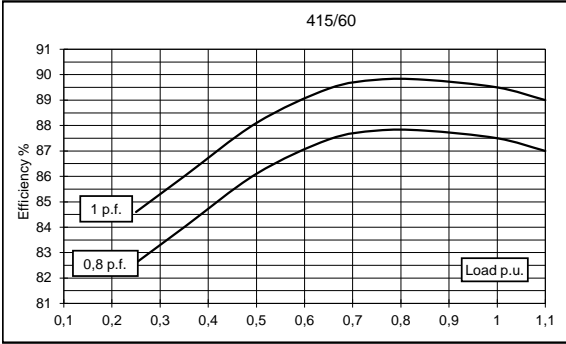

All technical data are to be considered as a reference and they can be modified without any notice
 This document is a propriety of Mecc Alte S.p.a.. All rights reserved.

TWO BEARING MOMENTS OF INERTIA

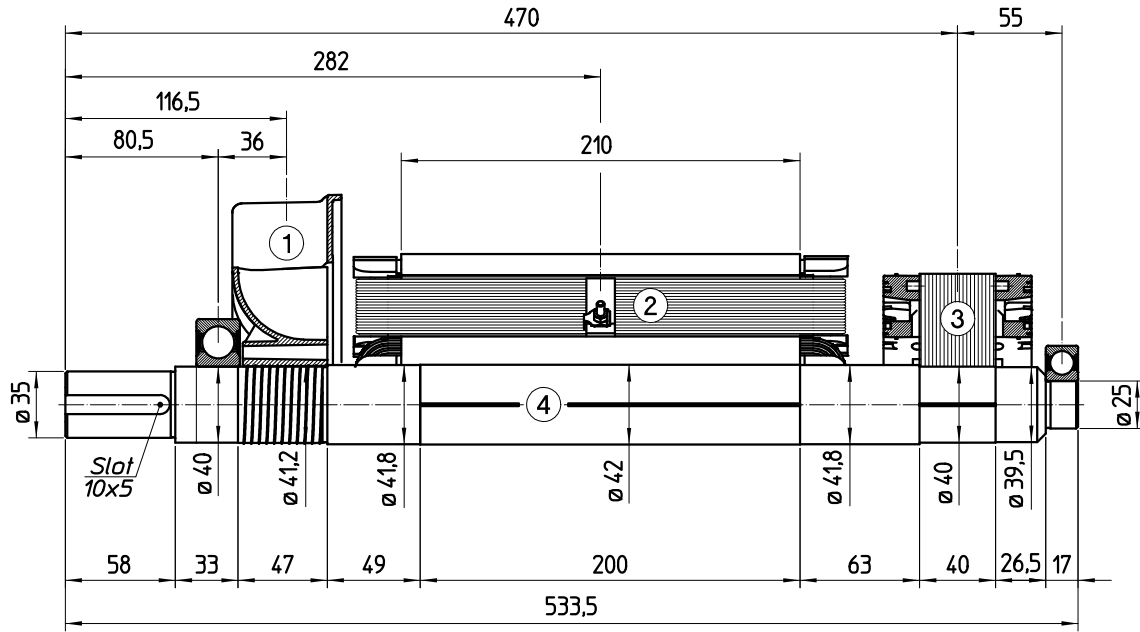

POS.	COMPONENT	WEIGHT (kg)	J (kgm ²)
1	FAN	0,4	0,00206
2	MAIN ROTOR	24,8	0,07634
3	EX. ROTOR	4,2	0,01086
4	SHAFT	5,2	0,00101
TOTAL		34,6	0,09027

TWO BEARING DIMENSIONS

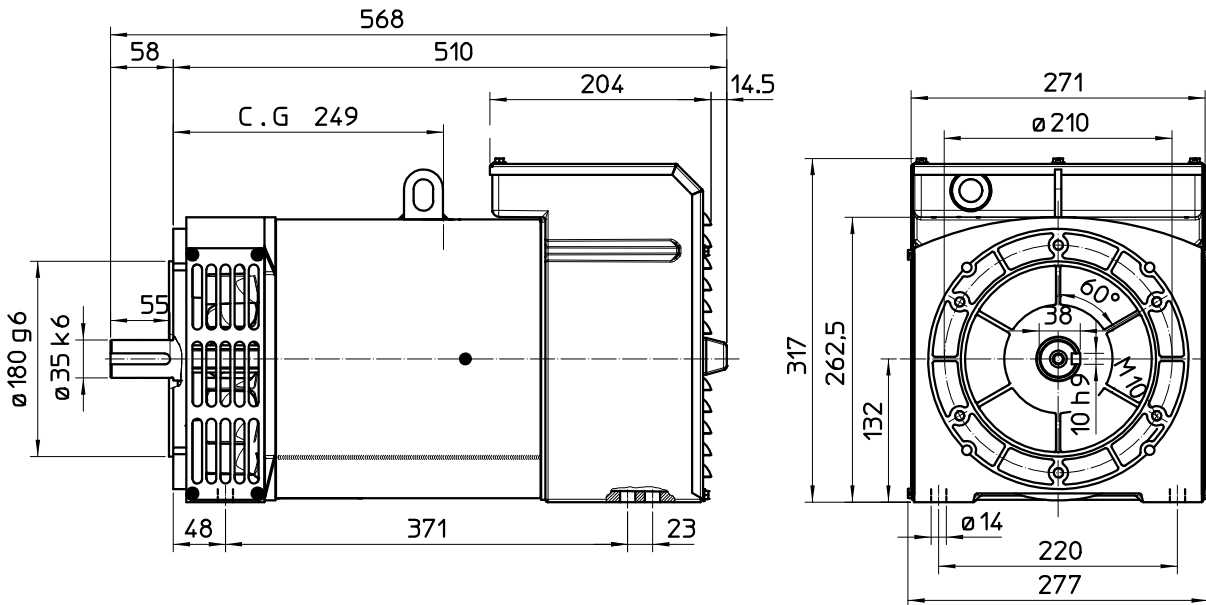

SINGLE BEARING MOMENTS OF INERTIA

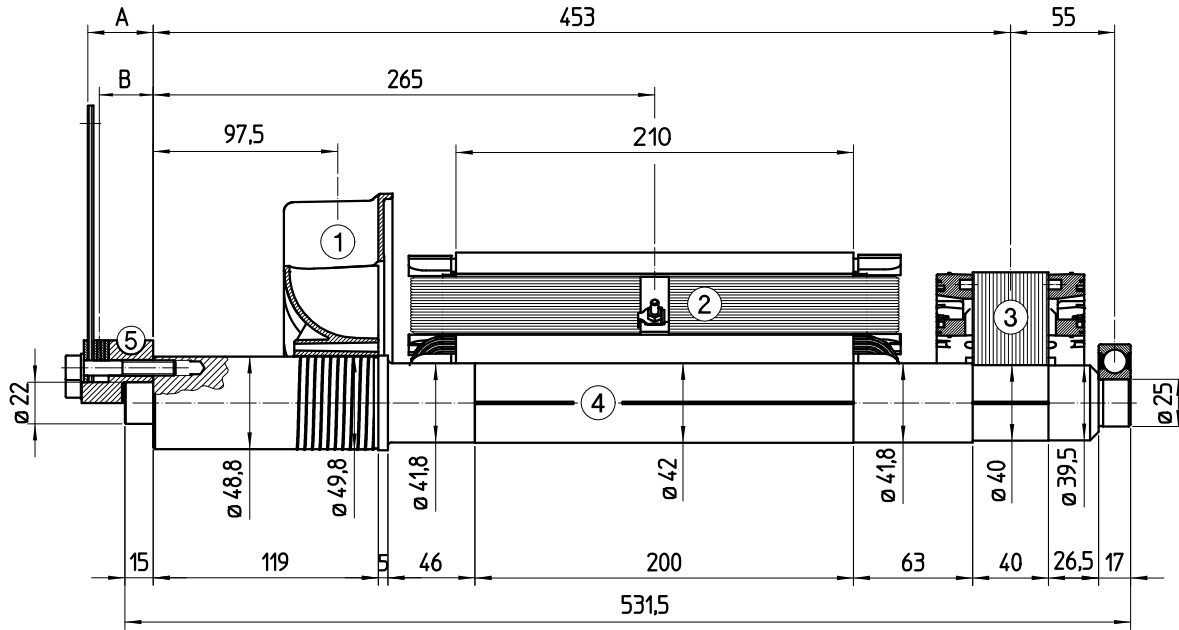

POS.	COMPONENT	WEIGHT (kg)	J (kgm ²)
1	FAN	0,4	0,00206
2	MAIN ROTOR	24,8	0,07634
3	EX. ROTOR	4,2	0,01086
4	SHAFT	5,8	0,00140
TOTAL		35,2	0,09066

SAE N°	SHAFTS COUPLING FLEX PLATE			
	A	B	WEIGHT kg	J kgm ²
5				
6 1/2	3	1,5	1,00	0,00495
7 1/2	3	1,5	1,20	0,00769
8	34,6	29,5	1,75	0,01114
10	26,6	23,5	2,14	0,02220
11 1/2	13	11	2,60	0,03524

SINGLE BEARING DIMENSIONS

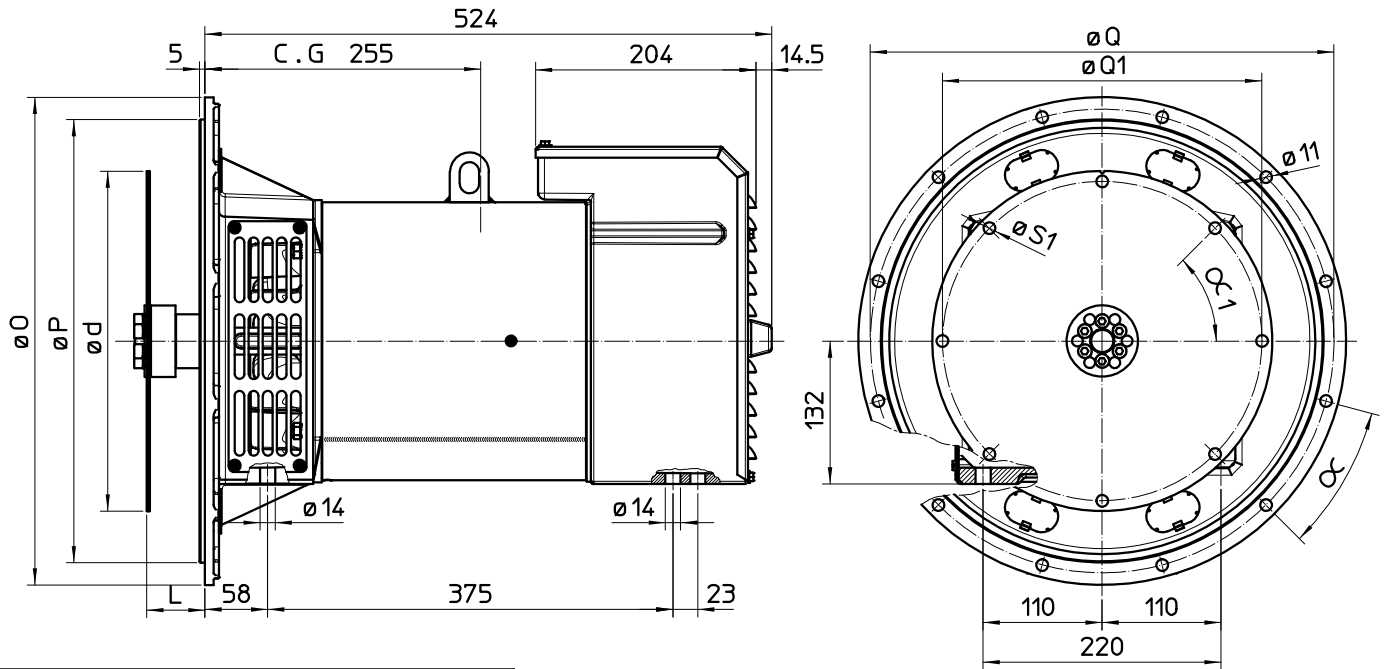

GIUNTO A DISCO / COUPLING DISC PLATEX						
SAE	L	d	Q1	Fori N° Holes N°	S1	α ₁
6 ‡	30,2	215,9	200	6	9	60°
7 ‡	30,2	241,3	222,25	8	9	45°
8	62	263,52	244,47	6	11	60°
10	53,8	314,52	295,27	8	11	45°
11 ‡	39,6	352,42	333,37	8	11	45°

FLANGIE / FLANGE					
SAE	O	P	Q	Fori N° Holes N°	α
6	308	266,7	285,75	8	22°30'
5	356	314,3	333,4	8	22°30'
4	403	362	381	12	15°
3	451	409,6	428,6	12	15°

C.G.= GRAVITY CENTER