



GENERATOR TYPE ECP 32-2L/2 A

Document : **DS294A/1**

issue 000 date 30/08/2013

Electrical Characteristics										
Frequency	Hz	50				60				
Voltage (star)	V	380	400	415	440	415	440	460	480	
Rated power class H	kVA	82	82	80	67	84	93	98,5	98,5	
	kW	65,6	65,6	64	53,6	67,2	74,4	78,8	78,8	
Rated power class F	kVA	75	75	73	61	76	85	90	90	
	kW	60	60	58,4	48,8	60,8	68	72	72	
Regulation with DSR		±1 % with any power factor and speed variations between -5% +30%								
Insulation class		H								
Execution		Brushless								
Stator winding		12 ends								
Rotor		with damping cage								
Efficiencies class H	4/4	%	88,9	89	88,7	88,5	89,8	90,3	90,4	90,5
(see graph. for details)	3/4	%	89,1	89,4	89,3	89	90,2	90,4	90,6	90,8
	2/4	%	86,4	86,5	86,5	86,2	86,9	87	87,1	87,2
	1/4	%	80,1	80	79,8	79,3	80,8	80,6	80,7	81
Reactances (f. l.cl. F)	Xd	%	574,0	518	469,5	349,8	591,0	582,0	564,0	518
	Xd'	%	13,35	12,05	10,92	8,14	13,75	13,54	13,12	12,05
	Xd''	%	6,04	5,45	4,94	3,68	6,22	6,12	5,93	5,45
	Xq	%	284,8	257	232,9	173,5	293,2	288,8	279,8	257
	Xq'	%	284,8	257	232,9	173,5	293,2	288,8	279,8	257
	Xq''	%	21,9	19,8	17,9	13,4	22,6	22,2	21,6	19,8
	X ₂	%	18,95	17,1	15,50	11,55	19,51	19,21	18,62	17,1
	X ₀	%	3,10	2,8	2,54	1,89	3,19	3,15	3,05	2,8
Short Circuit Ratio	Kcc		0,45	0,57	0,67	1,27	0,32	0,37	0,45	0,57
Time Constants	Td'	sec.	0,075							
	Td''	sec.	0,016							
	Tdo'	sec.	1,40							
	Tα	sec.	0,016							
Short Circuit Current Capacity		%	>300				>320			
Excitation at no load	Amp.		0,5	0,6	0,7	0,85	0,3	0,4	0,45	0,5
Excitation at full load	Amp.		1,6	1,7	1,8	1,9	1,3	1,4	1,5	1,6
Overload (long-term)	%	1 hour in a 6 hours period 110% rated load								
Overload per 20 sec.	%	300								
Stator Winding Resistance (20 °C)	Ω	0,034								
Rotor Winding Resistance (20 °C)	Ω	4,68								
Exciter Resistance (20 °C)	Ω	Rotor : 0,475				Stator : 11,35				
Heat dissipation at f.l.cl.H	W	8191	8108	8153	6965	7633	7992	8368	8272	
Telephone Interference		THF < 2%				TIF < 50				
Radio interference		EN61000-6-3, EN61000-6-1. For others standards apply to factory								
Waveform Distors.(THD) at f. load	LL/LN %	3,3 / 2,9								
Waveform Distors.(THD) at no load	LL/LN %	4,5 / 4								
Mechanical characteristics										
Protection		IP 21 (other protection on request)								
DE bearing		6312-2Z								
NDE bearing		6309-2RS								
Weight of wound stator assembly	kg	79,5								
Weight of wound rotor assembly	kg	52								
Weight of complete generator	kg	231								
Maximun overspeed	rpm	4320								
Unbalanced magnetic pull at f.l.cl.F	kN/mm	4,1								
Cooling air requirement	m ³ /min	22,4				27				
Inertia Constant (H)	sec.	0,312				0,374				
Noise level at 1m/7m	dB(A)	88 / 77				93 / 80				

All technical data are to be considered as a reference and they can be modified without any notice

This document is a propriety of Mecc Alte S.p.a..All rights reserved.

50 Hz

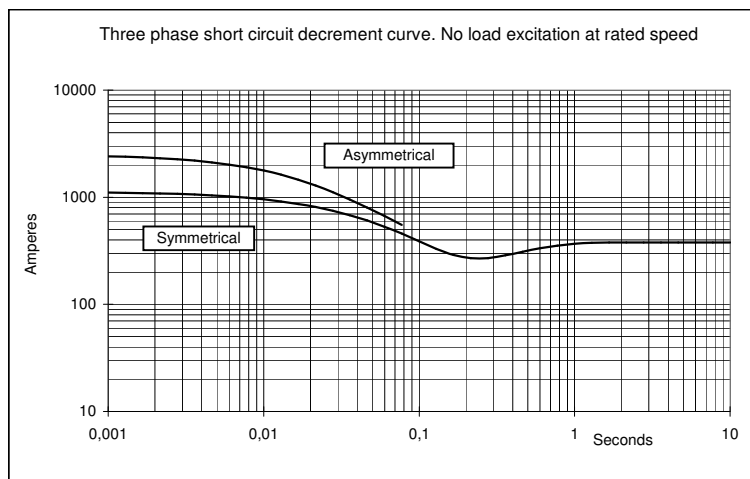
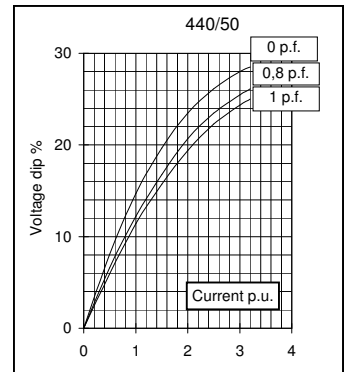
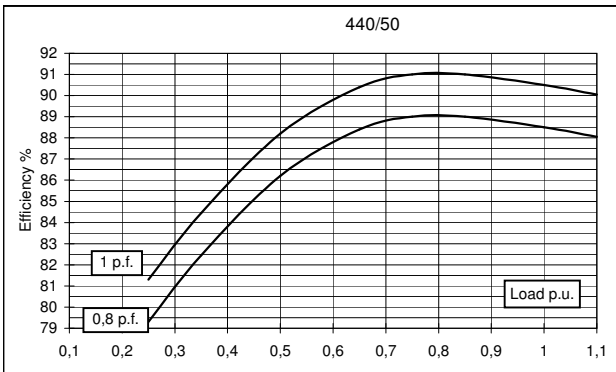
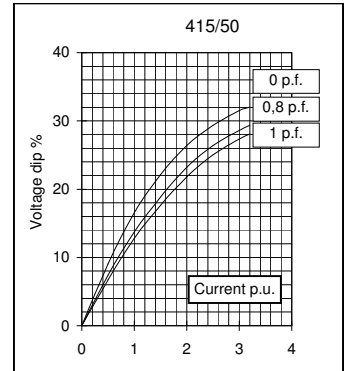
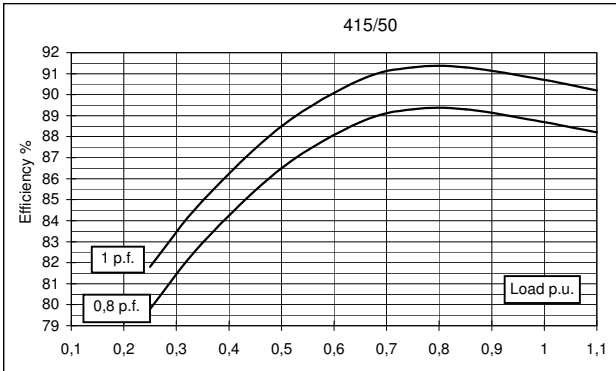
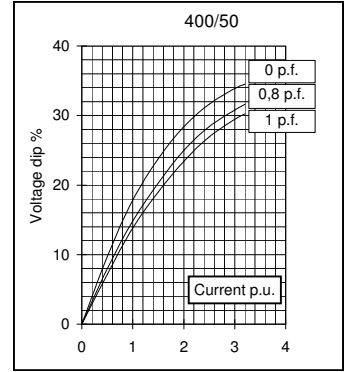
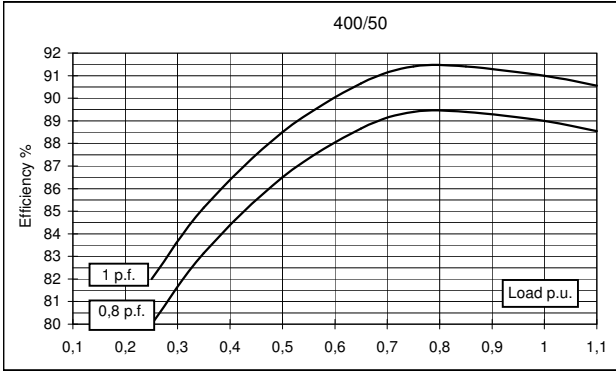
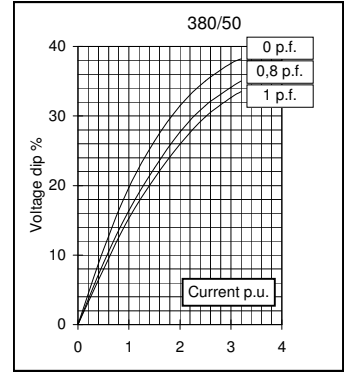
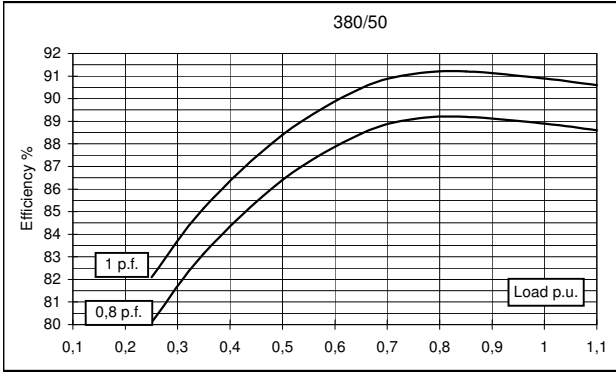

60 Hz

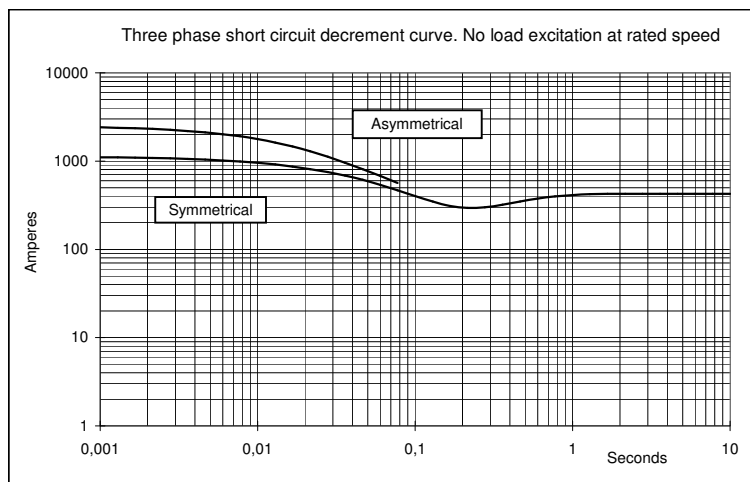
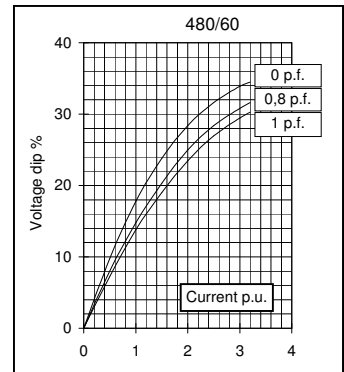
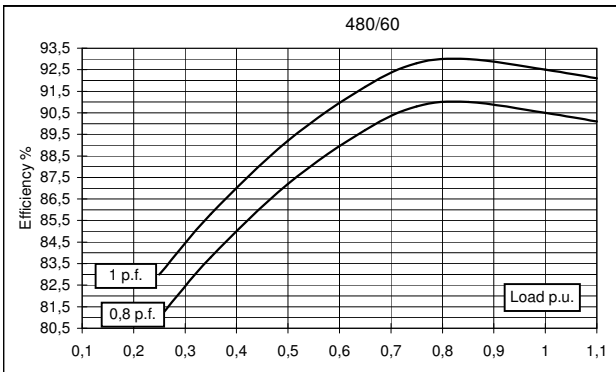
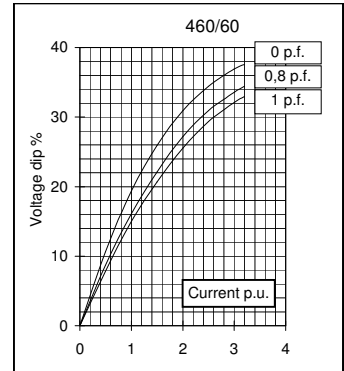
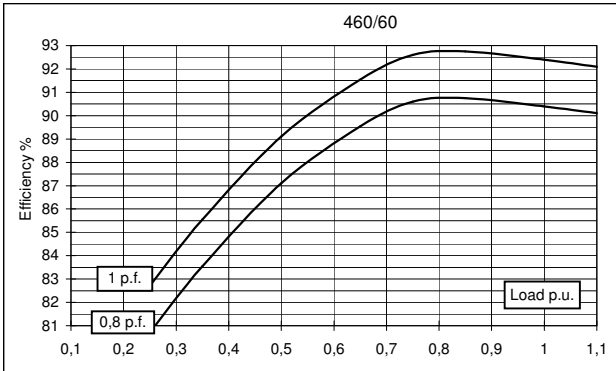
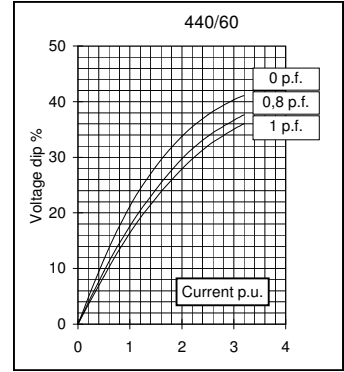
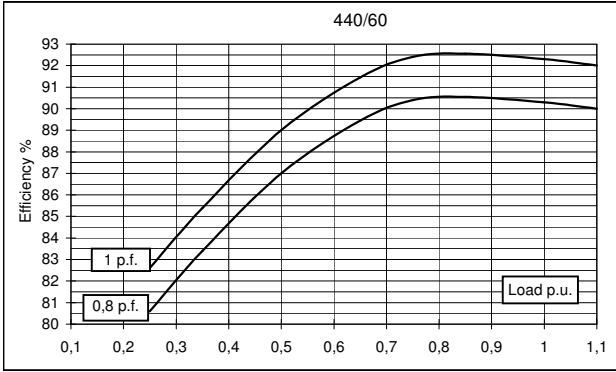
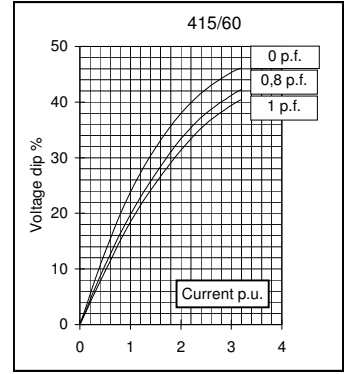
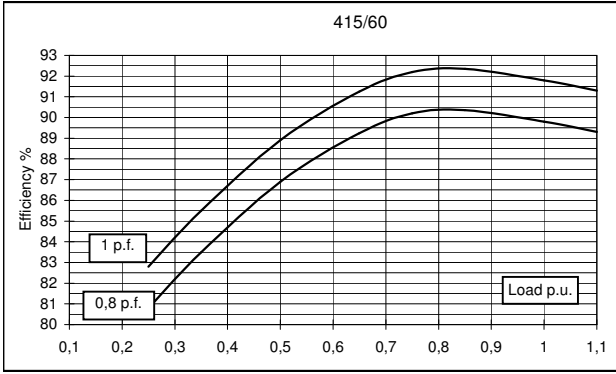

TWO BEARING MOMENTS OF INERTIA

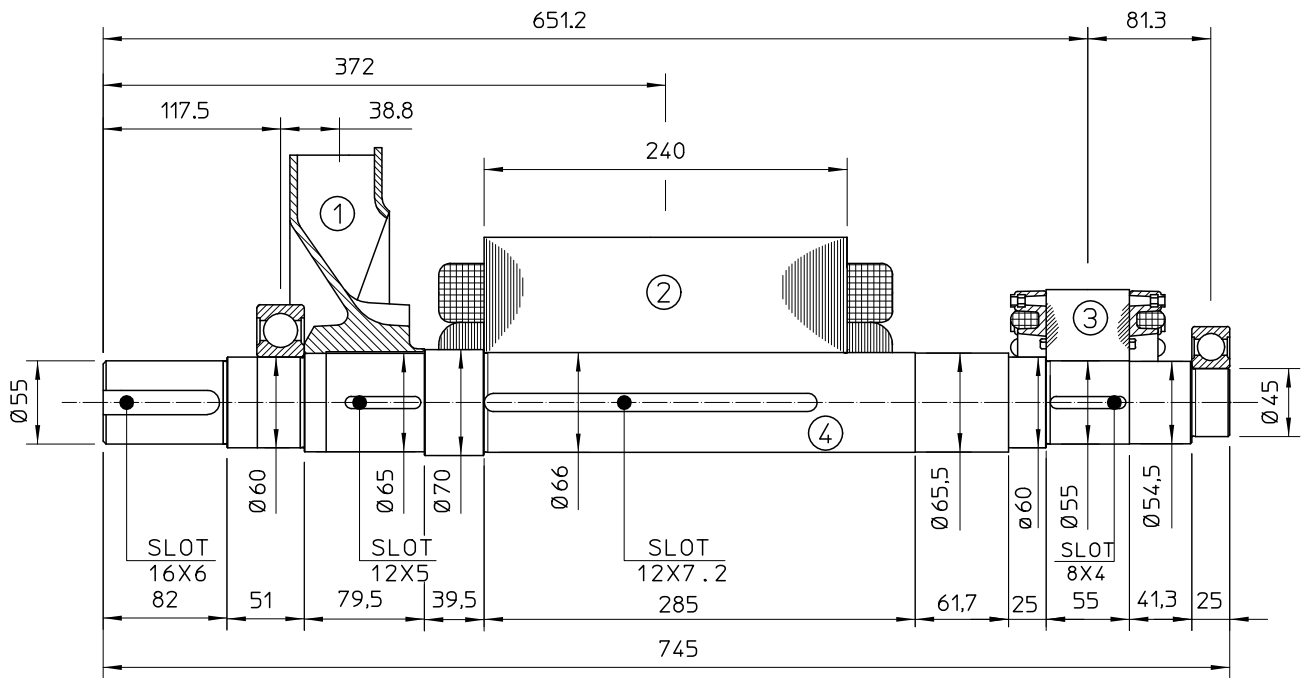

POS.	COMPONENT	WEIGHT (kg)	J (kgm ²)
1	FAN	2.3	0.0224
2	MAIN ROTOR	52	0.195
3	EX. ROTOR	7	0.016
4	SHAFT	17.5	0.008
TOTAL		78.8	0.2414

TWO BEARING DIMENSIONS

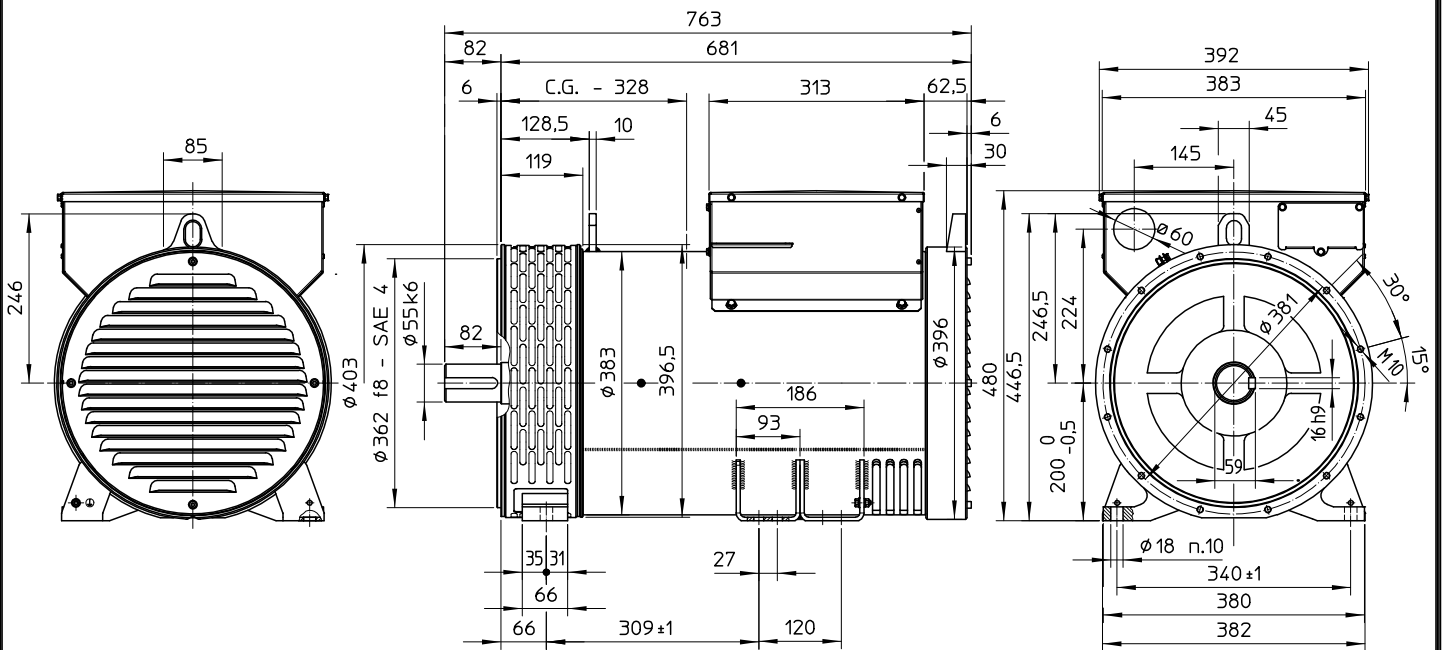

C.G.= GRAVITY CENTER

SINGLE BEARING MOMENTS OF INERTIA

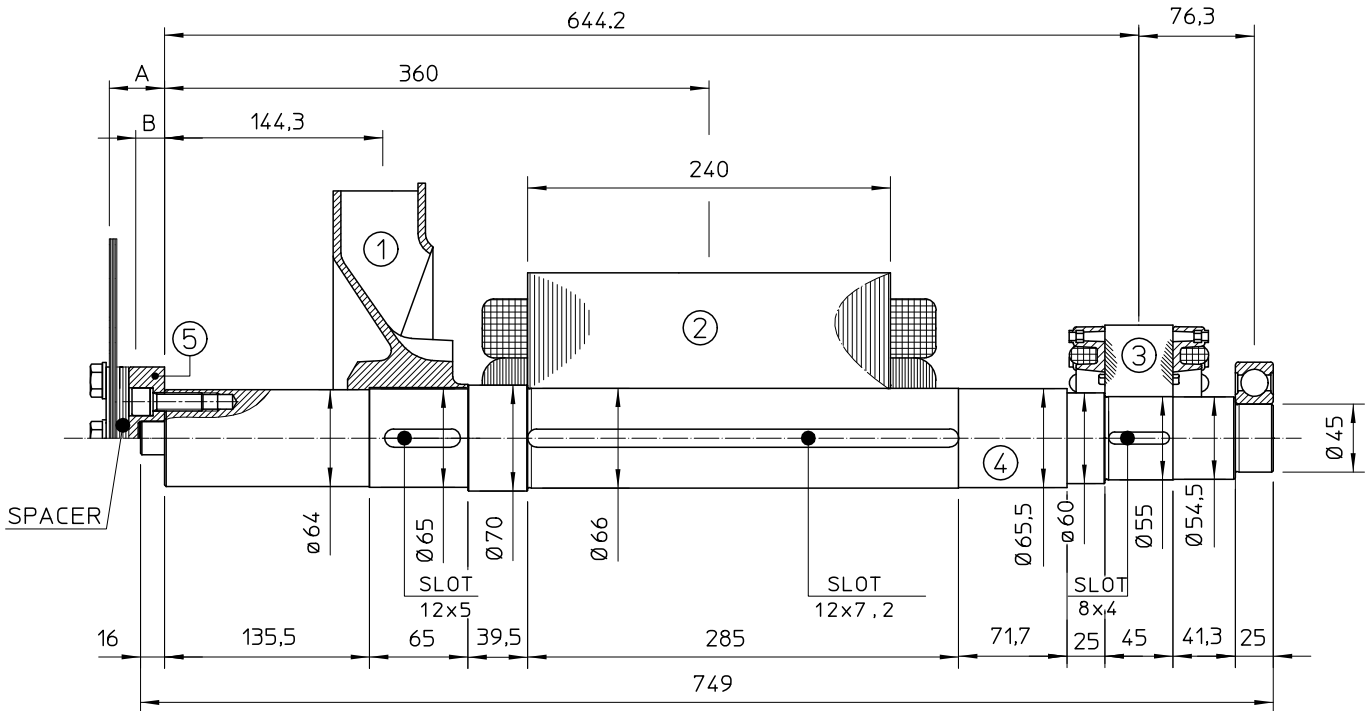

POS.	COMPONENT	WEIGHT (kg)	J (kgm ²)
1	FAN	2.3	0.0224
2	MAIN ROTOR	52	0.195
3	EX. ROTOR	7	0.016
4	SHAFT	18.3	0.0094
TOTAL		79.6	0.2428

SAE N°	5		SHAFTS COUPLING FLEX PLATE	
	A	B	WEIGHT kg	J kgm ²
6.5	5	2.5	1.74	0.0084
7.5	5	2.5	2.1	0.013
8	36.6	28.1	3.9	0.02
10	28.6	21.6	4.47	0.038
11.5	15	11.5	4.51	0.059

SINGLE BEARING DIMENSIONS

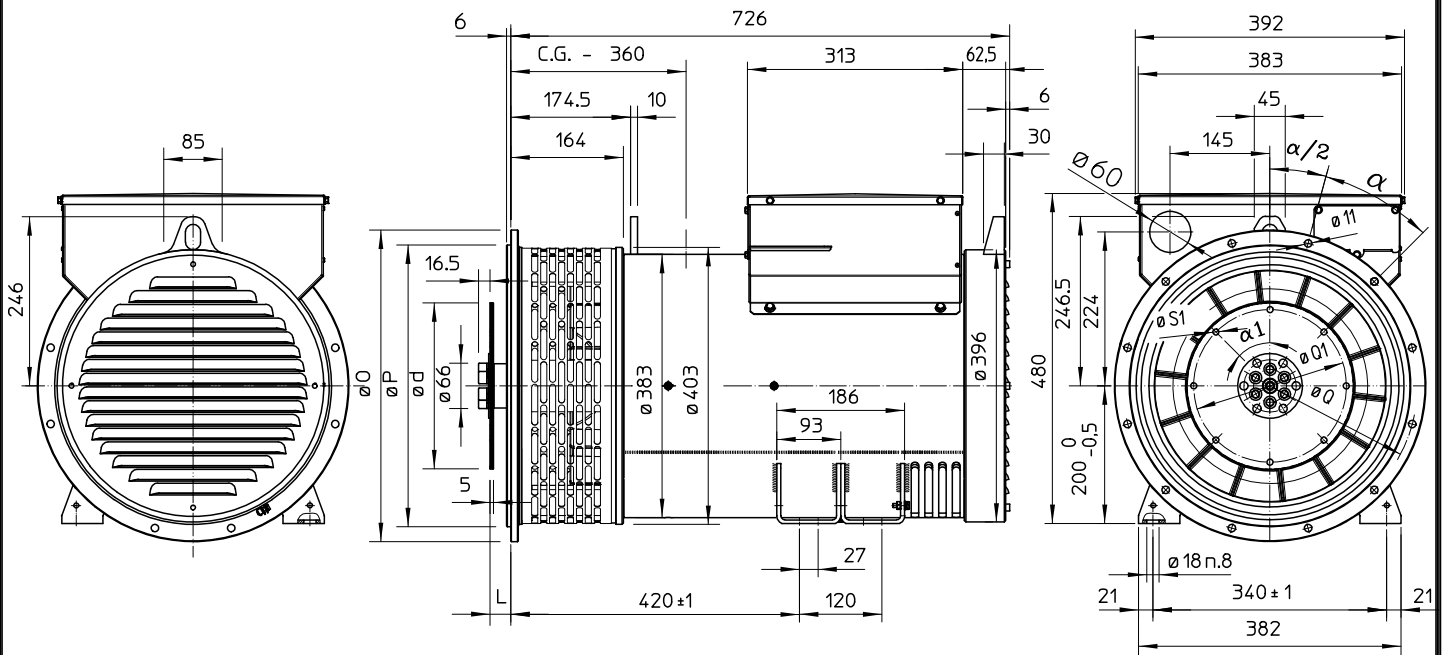

SAE N.	FLANGIA / FLANGE BRIDE / FLANSCH			
	O	P	Q	α
5	356	314.3	333.4	45°
4	403	362	381	30°
3	451	409.6	428.6	30°
2	490	447.7	466.7	30°
1	552	511.2	530.2	30°

SAE N.	GIUNTI A DISCHI / DISC COUPLING DISCQUE DE MONOPALIER / SCHEIBENKUPPLUNG				
	d	L	Q1	S1	α1
6 1/2	215.9	30.2	200	9	60°
7 1/2	241.3	30.2	222.25	9	45°
8	263.52	62	244.47	11	60°
10	314.32	53.8	295.27	11	45°
11 1/2	352.42	39.6	333.37	11	45°

C.G.= GRAVITY CENTER