



GENERATOR TYPE ECP 32-3S/4 A

Document : **DS287A/1**
 issue 000 date 30/08/2013

Electrical Characteristics										
Frequency	Hz	50				60				
Voltage (series star)	V	380	400	415	440	415	440	460	480	
Rated power class H	kVA	42,5	42,5	42,5	34	50	51	51	51	
	kW	34	34	34	27,2	40	40,8	40,8	40,8	
Rated power class F	kVA	39	39	39	31	46	49	49	49	
	kW	31,2	31,2	31,2	25	37	39,2	39,2	39,2	
Regulation with	DSR	±1 % with any power factor and speed variations between -5% +30%								
Insulation class		H								
Execution		Brushless								
Stator winding		12 ends								
Rotor		with damping cage								
Efficiencies class H	4/4	%	88,5	88,6	88,3	88,1	89,1	89,6	89,8	90
(see graph. for details)	3/4	%	88,8	89,1	89	88,7	89,9	90,2	90,4	90,6
	2/4	%	87,2	87,3	87,3	87,3	88,7	88,8	88,9	89
	1/4	%	84,9	85	84,8	84,3	87	87	87	87
Reactances (f. l.cl. F)	Xd	%	210,5	190	176,5	125,6	249,2	226,1	206,9	190
	Xd'	%	15,84	14,3	13,28	9,45	18,76	17,02	15,57	14,3
	Xd''	%	11,08	10	9,29	6,61	13,12	11,90	10,89	10
	Xq	%	108,6	98	91,0	64,8	128,5	116,6	106,7	98
	Xq'	%	108,6	98	91,0	64,8	128,5	116,6	106,7	98
	Xq''	%	33,9	30,6	28,4	20,2	40,1	36,4	33,3	30,6
	X ₂	%	23,82	21,5	19,97	14,21	28,20	25,59	23,41	21,5
	X ₀	%	2,99	2,7	2,51	1,79	3,54	3,21	2,94	2,7
Short Circuit Ratio	Kcc		0,70	0,80	0,90	1,30	0,40	0,60	0,70	0,80
Time Constants	Td'	sec.	0,061							
	Td''	sec.	0,015							
	Tdo'	sec.	1,32							
	Tα	sec.	0,031							
Short Circuit Current Capacity		%	>300				>350			
Excitation at no load	Amp.		0,6	0,7	1	1,3	0,3	0,4	0,5	0,6
Excitation at full load	Amp.		2,3	2,4	2,6	2,9	2,1	2	2,2	2,3
Overload (long-term)		%	1 hour in a 6 hours period 110% rated load							
Overload per 20 sec.		%	300							
Stator Winding Resistance (20 °C)	Ω		0,078							
Rotor Winding Resistance (20 °C)	Ω		2,163							
Exciter Resistance (20 °C)	Ω		Rotor : 0,417				Stator : 10,6			
Heat dissipation at f.l.cl.H	W		4418	4375	4505	3674	4893	4736	4634	4533
Telephone Interference			THF < 2%				TIF < 45			
Radio interference			EN61000-6-3, EN61000-6-1. For others standards apply to factory							
Waveform Distors.(THD) at f. load	LL/LN %		3,7 / 3,6							
Waveform Distors.(THD) at no load	LL/LN %		3,2 / 3,1							
Mechanical characteristics										
Protection			IP 21 (other protection on request)							
DE bearing			6312-2RS							
NDE bearing			6309-2RS							
Weight of wound stator assembly	kg		62,5							
Weight of wound rotor assembly	kg		43,5							
Weight of complete generator	kg		209							
Maximun overspeed	rpm		2250							
Unbalanced magnetic pull at f.l.cl.F	kN/mm		4,5							
Cooling air requirement	m³/min		11,8				14,5			
Inertia Constant (H)	sec.		0,102				0,122			
Noise level at 1m/7m	dB(A)		75 / 60				79 / 64			

All technical data are to be considered as a reference and they can be modified without any notice.

50 Hz

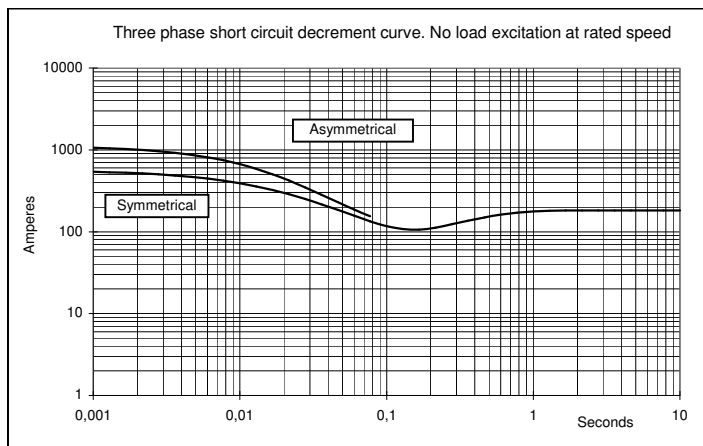
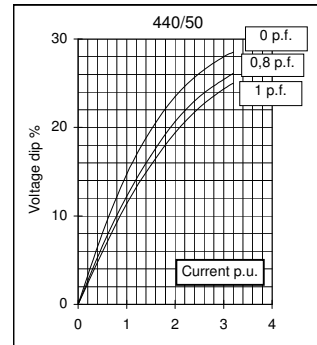
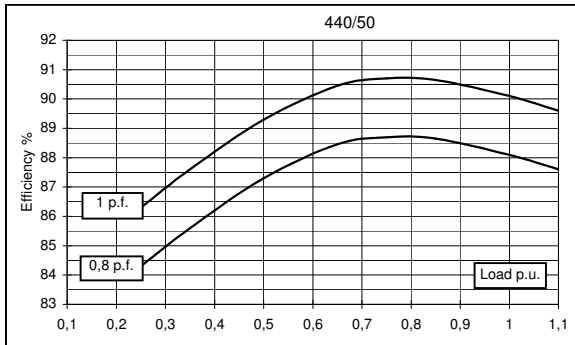
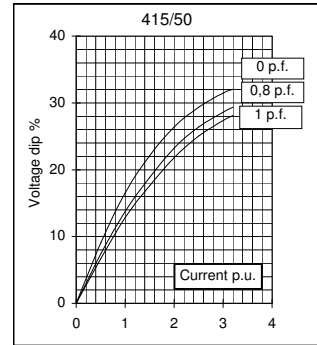
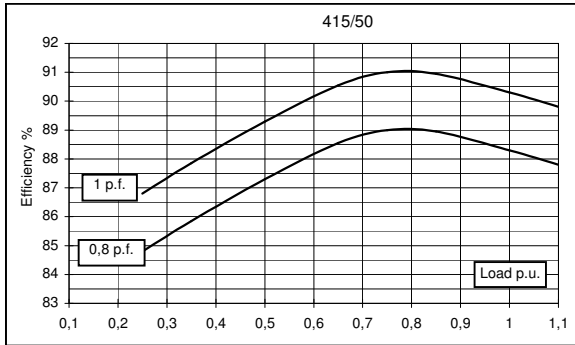
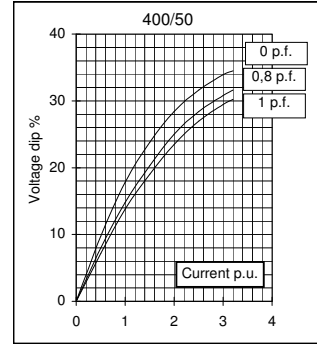
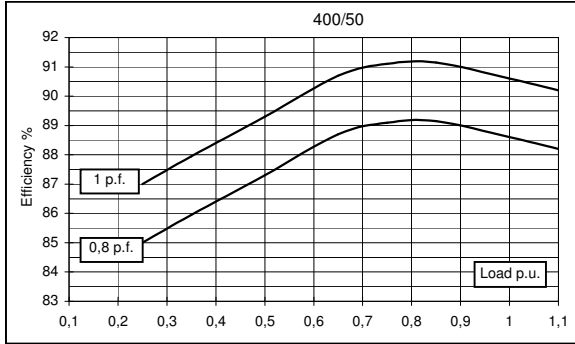
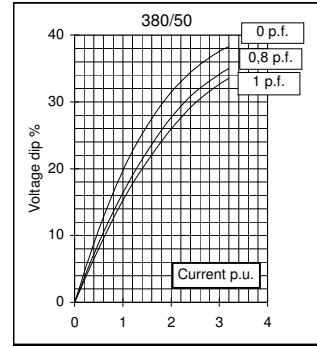
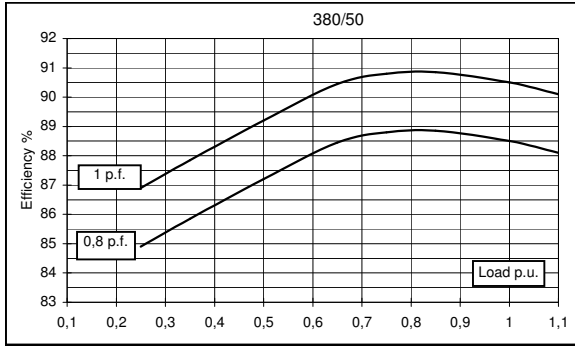

60 Hz

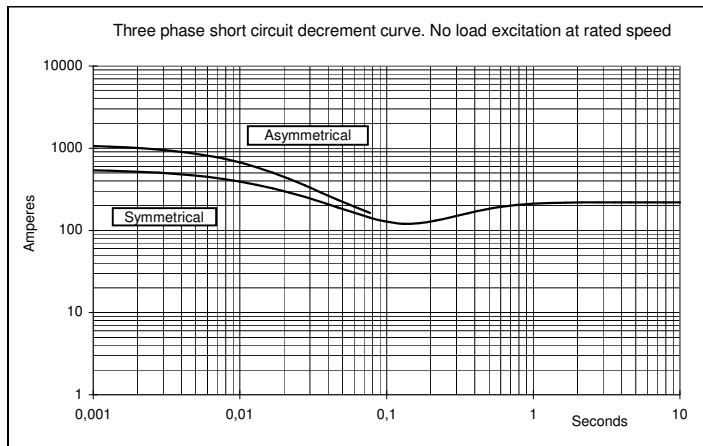
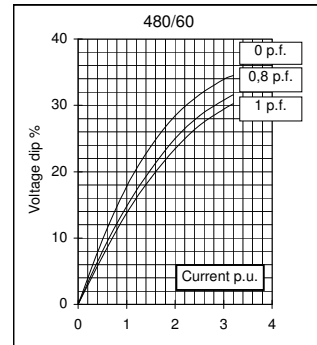
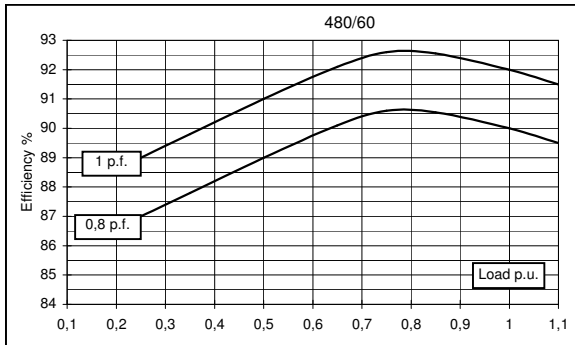
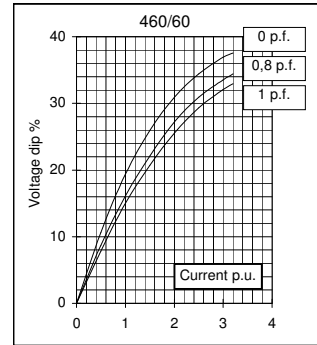
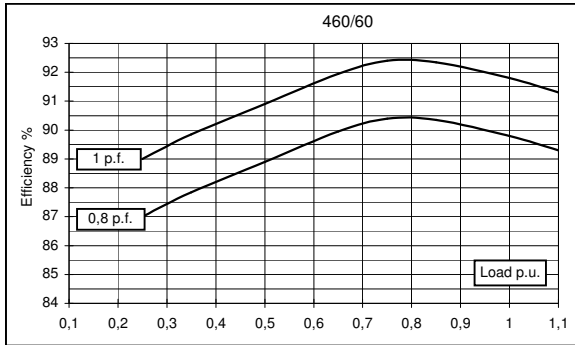
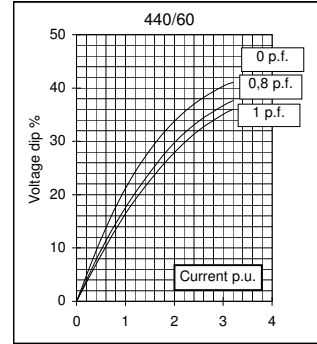
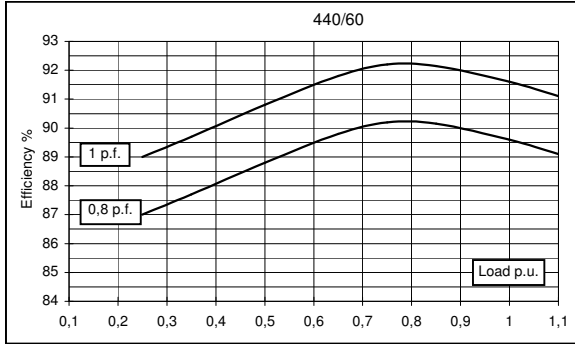
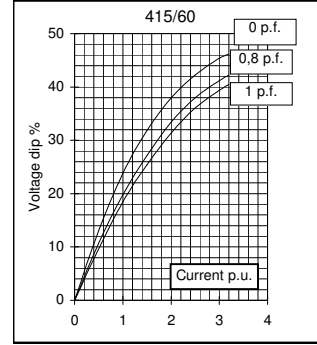
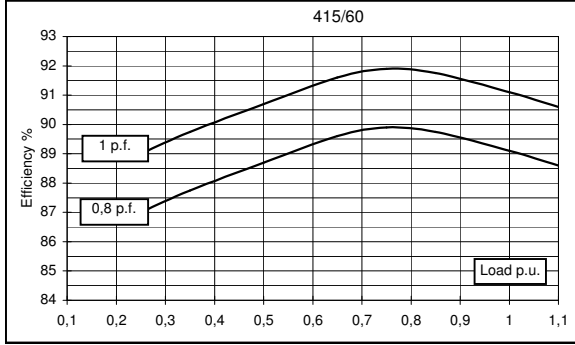

TWO BEARING MOMENTS OF INERTIA

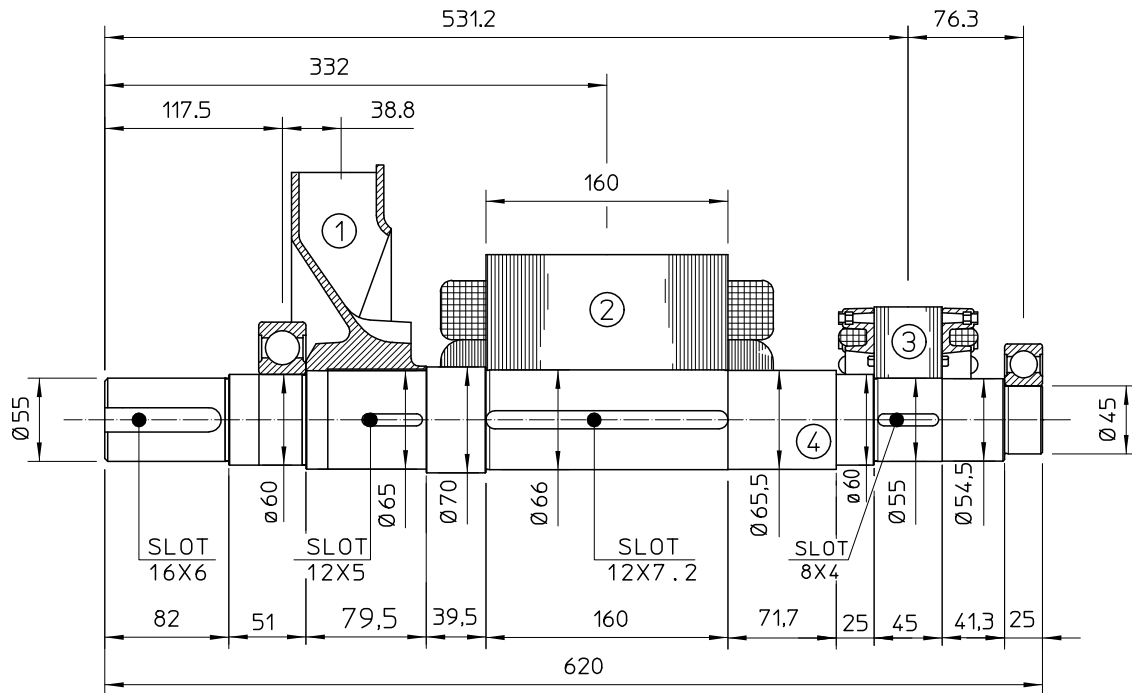

POS.	COMPONENT	WEIGHT (kg)	J (kgm ²)
1	FAN	2.3	0.0224
2	MAIN ROTOR	43.5	0.3088
3	EX. ROTOR	5.4	0.012
4	SHAFT	14.1	0.0069
TOTAL		65.3	0.3501

TWO BEARING DIMENSIONS

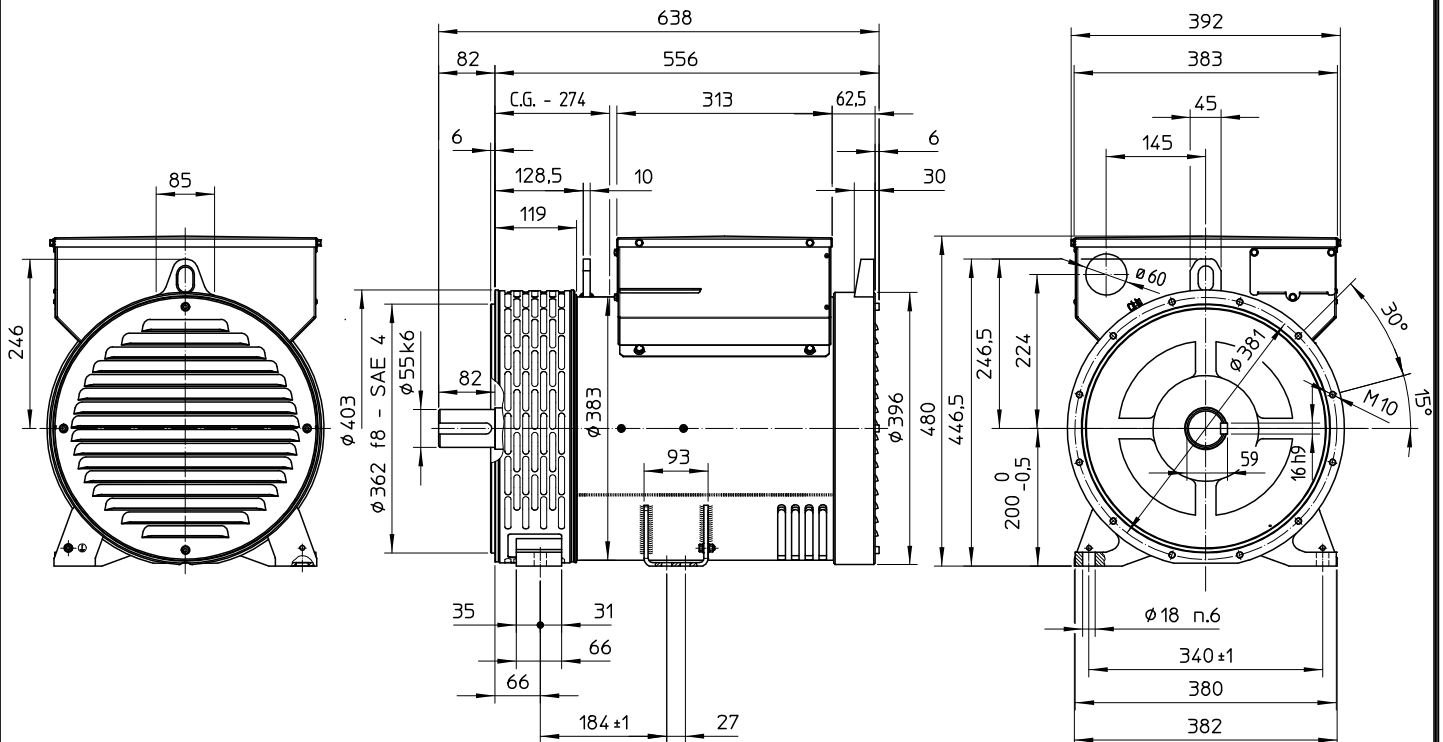

C.G.= GRAVITY CENTER

SINGLE BEARING MOMENTS OF INERTIA

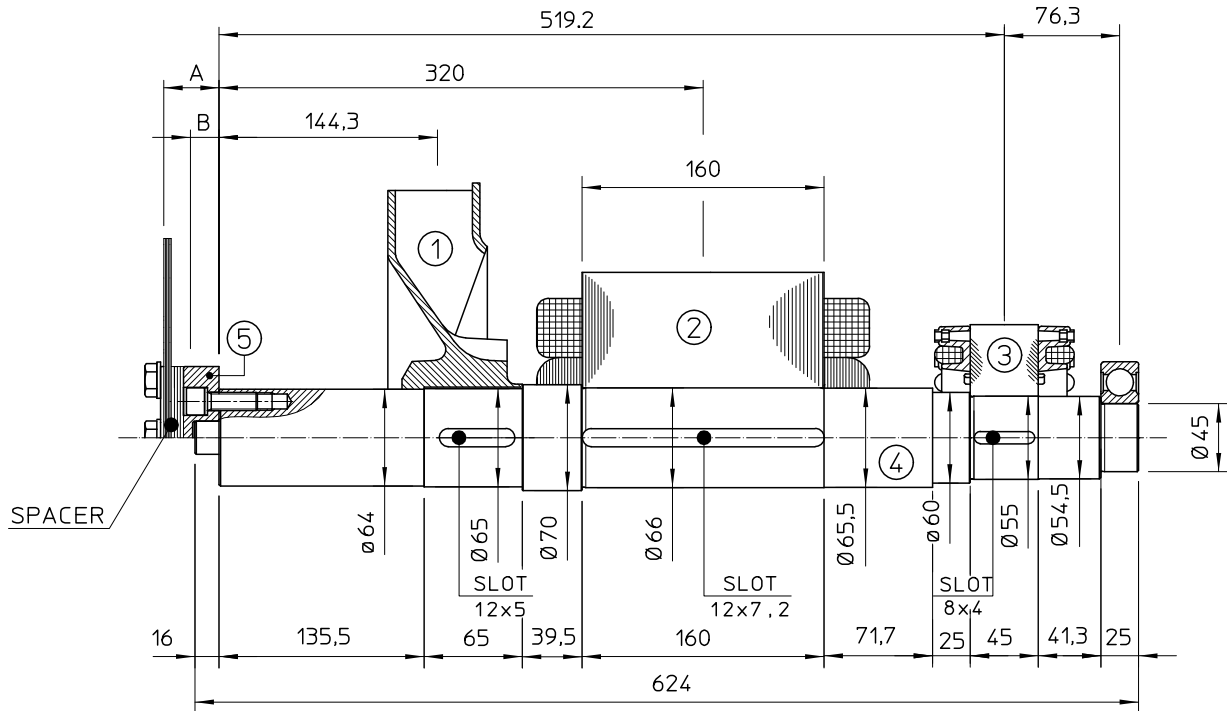

POS.	COMPONENT	WEIGHT (kg)	J (kgm ²)
1	FAN	2.3	0.0224
2	MAIN ROTOR	43.5	0.3088
3	EX. ROTOR	5.4	0.012
4	SHAFT	14.5	0.0074
TOTAL		65.7	0.3506

SAE N°	5		SHAFTS COUPLING FLEX PLATE	
	A	B	WEIGHT kg	J kgm ²
6.5	5	2.5	1.74	0.0084
7.5	5	2.5	2.1	0.013
8	36.6	28.1	3.9	0.02
10	28.6	21.6	4.47	0.038
11.5	15	11.5	4.51	0.059

SINGLE BEARING DIMENSIONS

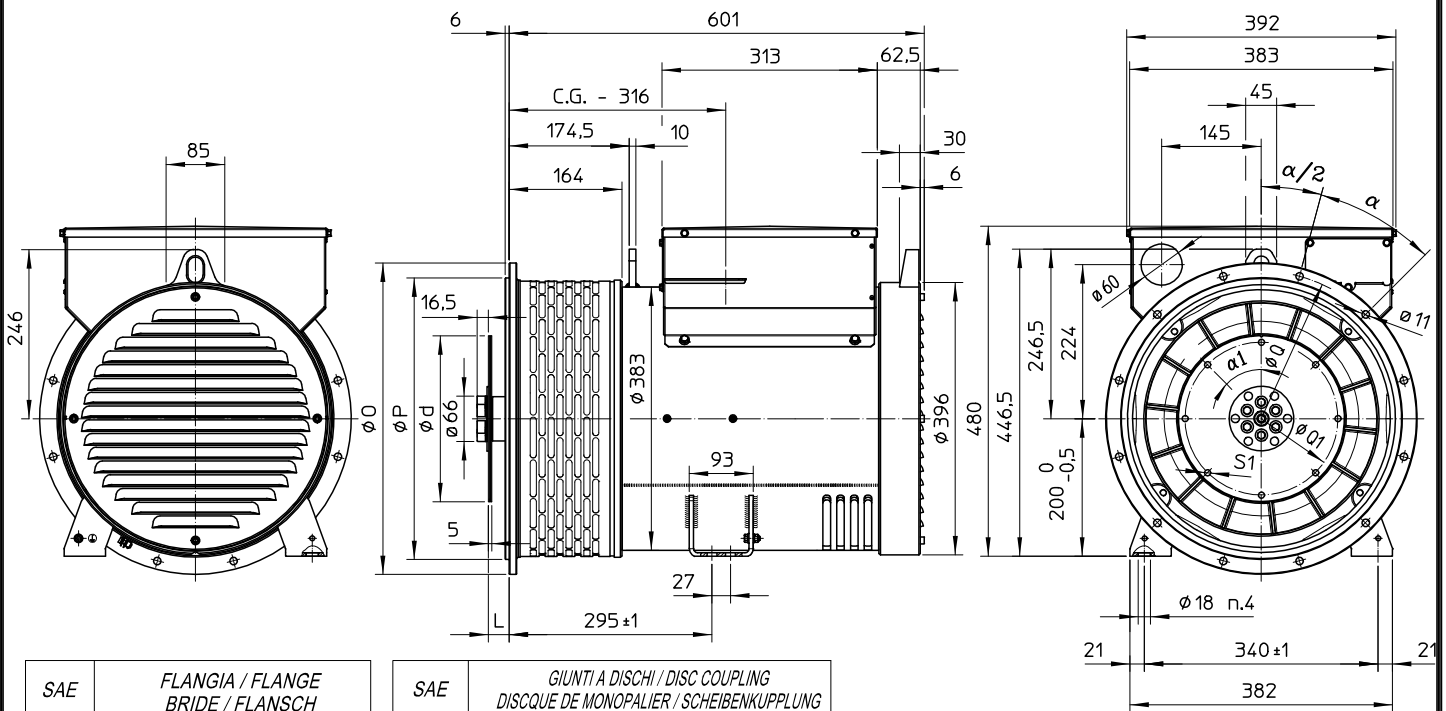

SAE N.	FLANGIA / FLANGE BRIDE / FLANSCH			
	O	P	Q	α
5	356	314.3	333.4	45°
4	403	362	381	30°
3	451	409.6	428.6	30°
2	490	447.7	466.7	30°
1	552	511.2	530.2	30°

SAE N.	GIUNTI A DISCHI / DISC COUPLING DISCQUE DE MONOPALIER / SCHEIBENKUPPLUNG				
	d	L	Q1	S1	α1
6 1/2	215.9	30.2	200	9	60°
7 1/2	241.3	30.2	222.25	9	45°
8	263.52	62	244.47	11	60°
10	314.32	53.8	295.27	11	45°
11 1/2	352.42	39.6	333.37	11	45°

C.G.= GRAVITY CENTER