



# GENERATOR TYPE ECP 34-1S/2

Document : **DS065A/1**

issue 001 date 02/04/2009

Electrical Characteristics										
Frequency	Hz	50				60				
Voltage (series star)	V	380	400	415	440	415	440	460	480	
Rated power class H	kVA	100	100	100	85	105	120	120	120	
	kW	80	80	80	68	84	96	96	96	
Rated power class F	kVA	90	90	90	75	95	108	108	108	
	kW	72	72	72	60	76	86,4	86,4	86,4	
Regulation with	SR7/2	±1,5 % with any power factor and speed variations between -5% +30%								
Insulation class		H								
Execution		Brushless								
Stator winding		12 ends								
Rotor		with damping cage								
Efficiencies class H	4/4	%	89,9	90	89,7	89,5	91,1	91,6	91,7	91,8
(see graph. for details)	3/4	%	90,1	90,4	90,3	90	92,1	92,3	92,4	92,6
	2/4	%	88,9	89	89	88,8	90,2	90,3	90,4	90,5
	1/4	%	85,2	85	84,8	84,8	86,2	86,2	86,2	86
Reactances (f. l.cl. F)	Xd	%	412,2	372	345,6	261,3	435,4	442,7	405,1	372
	Xd'	%	18,2	16,4	15,2	11,5	19,2	19,5	17,9	16,4
	Xd''	%	9,8	8,8	8,2	6,2	10,3	10,5	9,6	8,8
	Xq	%	155,8	140,6	130,6	98,8	164,6	167,3	153,1	140,6
	Xq'	%	155,8	140,6	130,6	98,8	164,6	167,3	153,1	140,6
	Xq''	%	26,8	24,2	22,5	17,0	28,3	28,8	26,4	24,2
	X <sub>2</sub>	%	20,3	18,3	17,0	12,9	21,4	21,8	19,9	18,3
	X <sub>0</sub>	%	3,8	3,4	3,2	2,4	4,0	4,0	3,7	3,4
Short Circuit Ratio	Kcc		0,23	0,24	0,25	0,26	0,21	0,22	0,23	0,24
Time Constants	Td'	sec.	0,0385							
	Td''	sec.	0,0089							
	Tdo'	sec.	1,20							
	Tα	sec.	0,0202							
Short Circuit Current Capacity		%	>300				>350			
Excitation at no load	Amp.		0,3	0,4	0,5	0,7	0,2	0,23	0,25	0,3
Excitation at full load	Amp.		3,1	3	3,4	3,6	3,1	3	2,9	2,8
Overload (long-term)		%	1 hour in a 6 hours period 110% rated load							
Overload per 20 sec.		%	300							
Stator Winding Resistance (20°C)		Ω	0,095							
Rotor Winding Resistance (20°C)		Ω	1,45							
Exciter Resistance (20 °C)		Ω	Rotor : 0,410				Stator : 15,28			
Heat dissipation at f.l.cl.H	W		8988	8889	9186	7978	8206	8803	8689	8575
Telephone Interference			THF < 2%				TIF < 40			
Radio interference			EN60034-1. For others standards apply to factory							
Waveform Distors.(THD) at f. load	LL/LN %		3,2 / 4,7							
Waveform Distors.(THD) at no load	LL/LN %		2,2 / 3,6							
<b>Mechanical characteristics</b>										
Protection			IP 21 ( other protection on request )							
DE bearing			6314.2Z							
NDE bearing			6311.2RS							
Weight of wound stator assembly	kg		123							
Weight of wound rotor assembly	kg		91,7							
Weight of complete generator	kg		344							
Maximun overspeed	rpm		4300							
Unbalanced magnetic pull at f.l.cl.F	kN/mm		3,9							
Cooling air requirement	m <sup>3</sup> /min		35,4				42			
Inertia Constant (H)	sec.		0,063				0,076			
Noise level at 1m/7m	dB(A)		92/79				96/82			

All technical data are to be considered as a reference and they can be modified without any notice.

This document is a propriety of Mecc Alte S.p.a..All rights reserved.

## 50 Hz

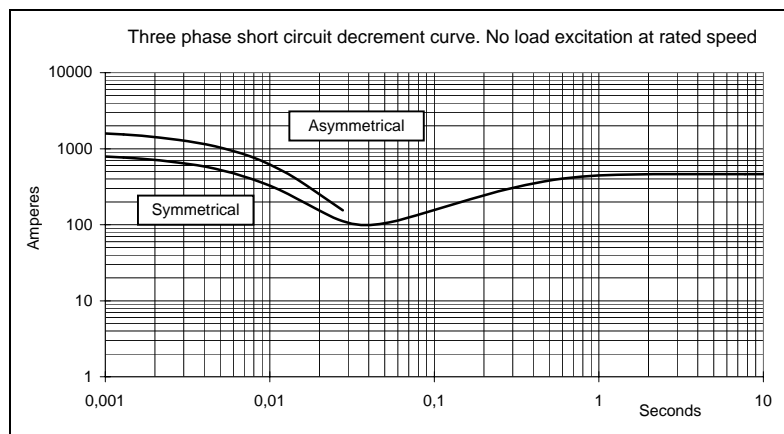
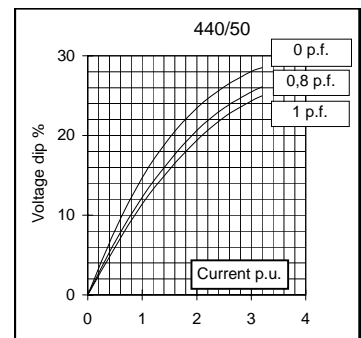
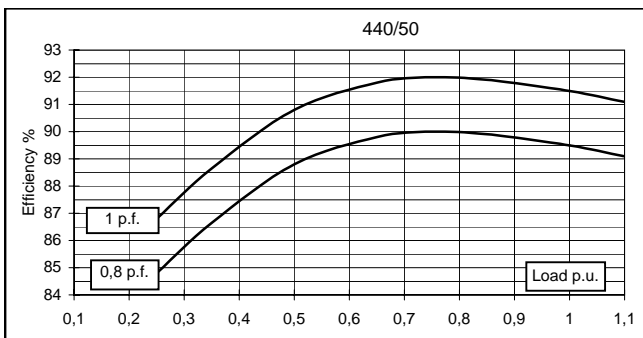
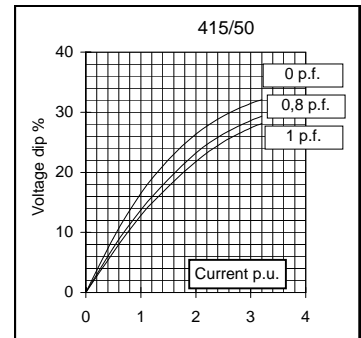
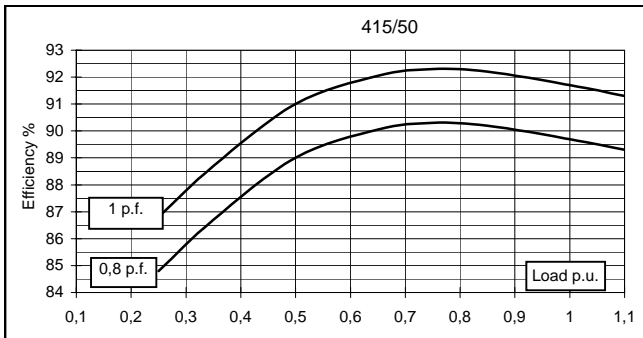
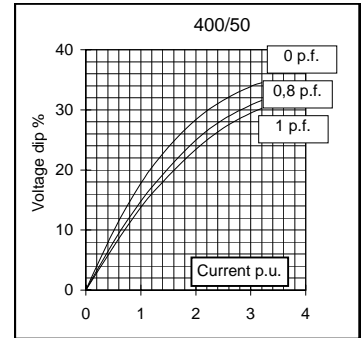
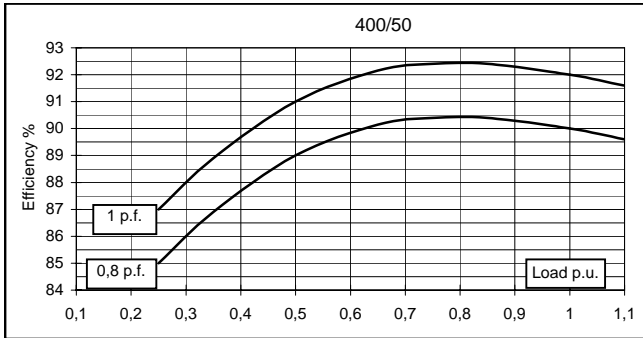
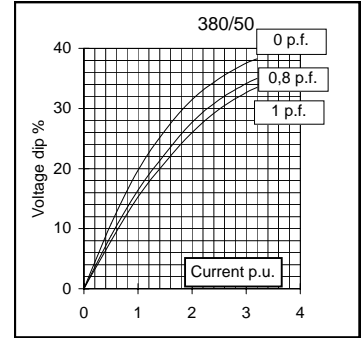
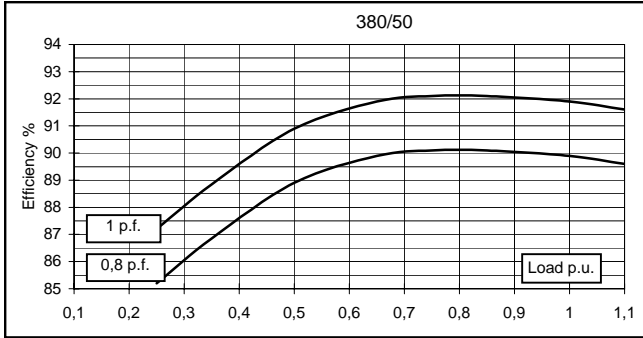

## 60 Hz

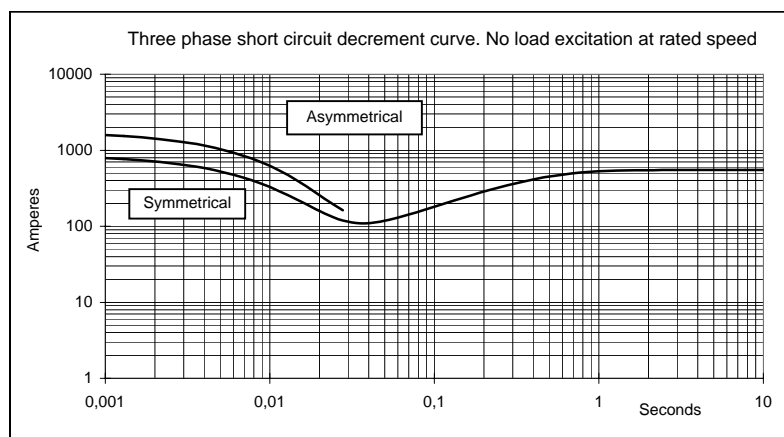
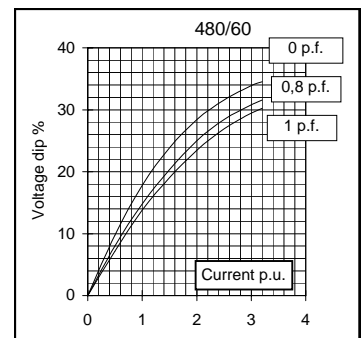
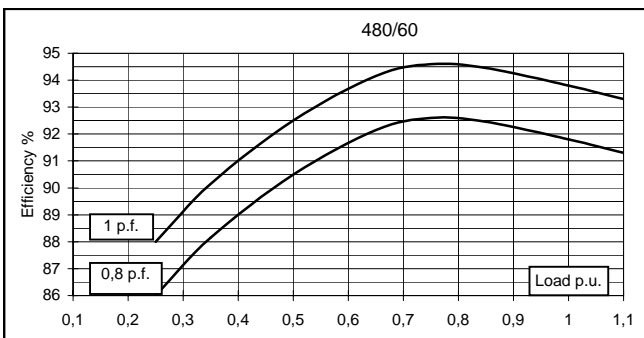
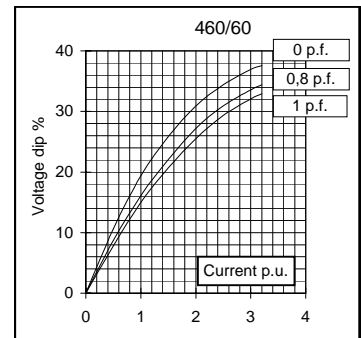
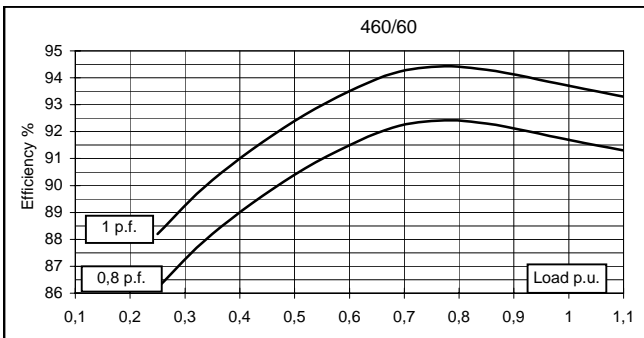
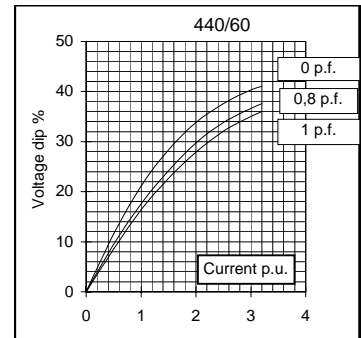
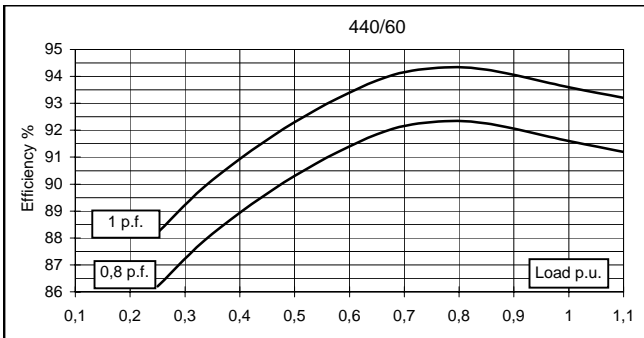
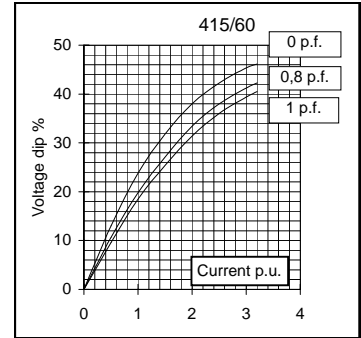
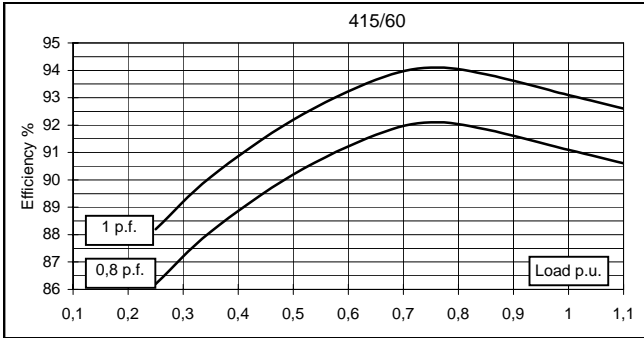

## TWO BEARING MOMENTS OF INERTIA

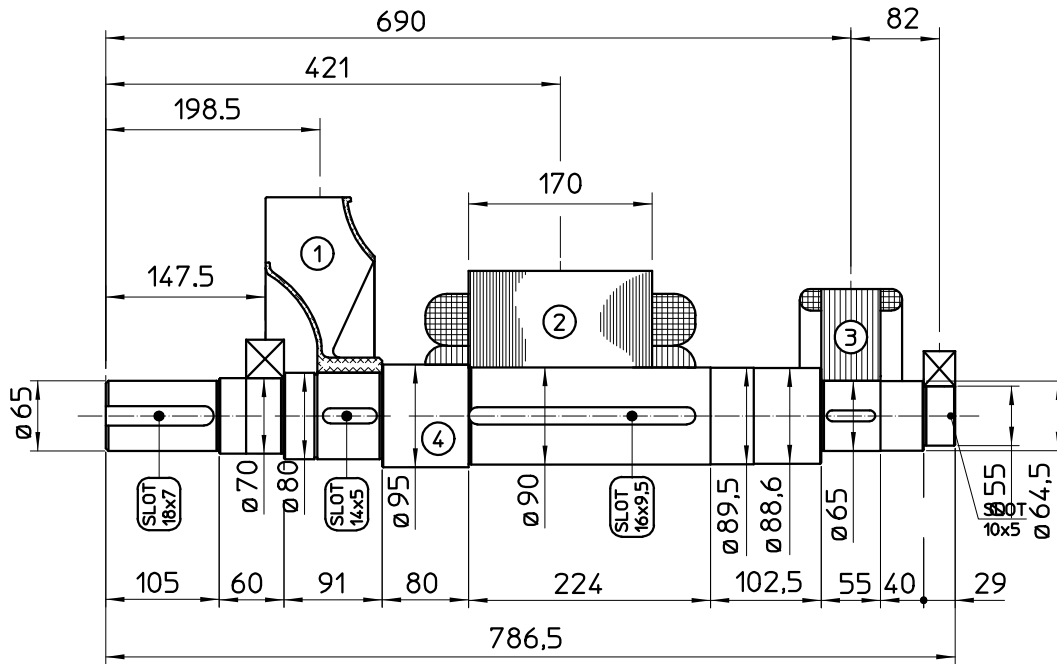

	COMPONENT	WEIGHT kg	J kgm <sup>2</sup>
1	FAN	3,3	0.0451
2	MAIN ROTOR	43	0.350
3	EX. ROTOR	14,5	0.0874
4	SHAFT	30,9	0.0274
	TOTAL	91,7	0.5099

## TWO BEARING DIMENSIONS

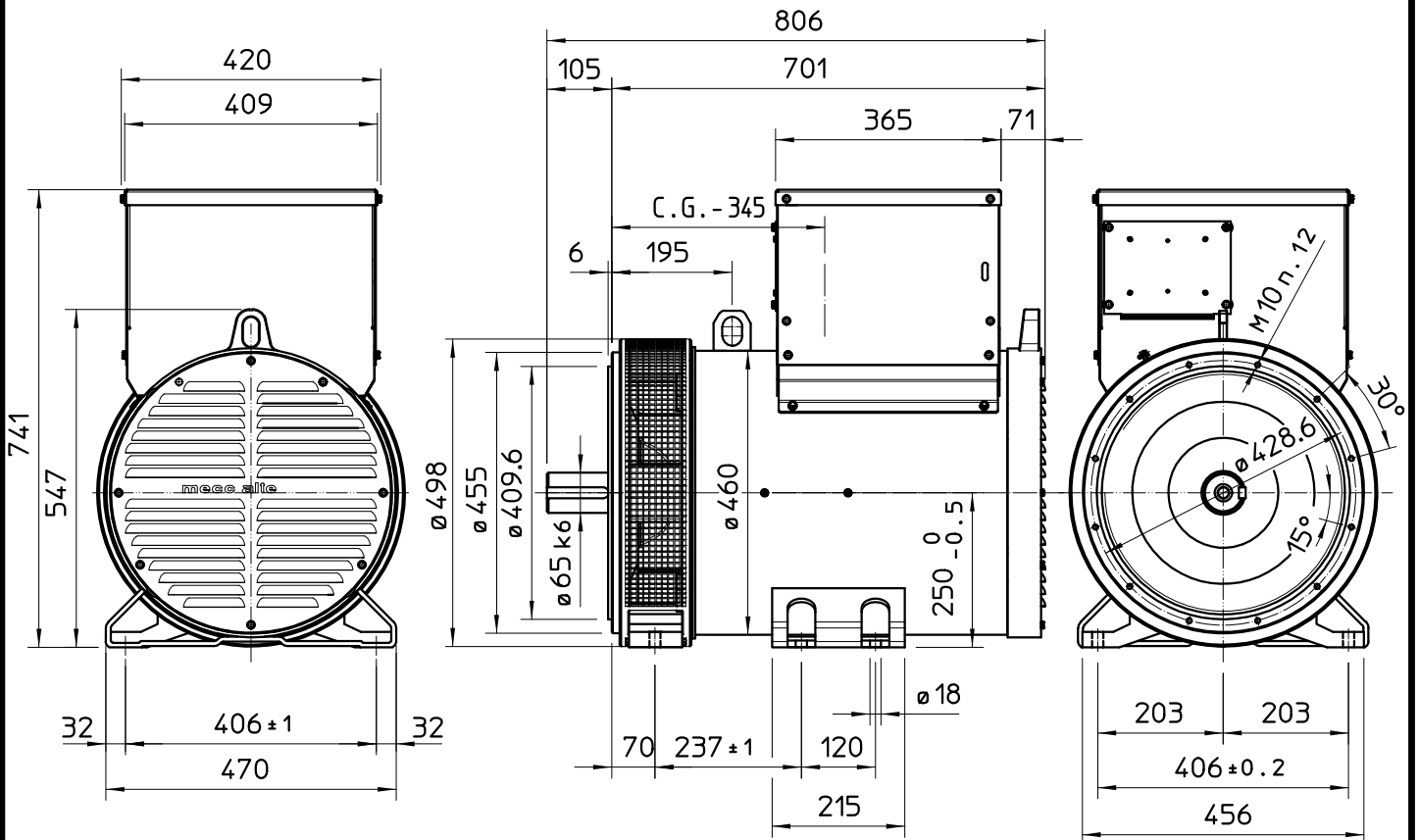

C.G. = GRAVITY CENTER

## SINGLE BEARING MOMENTS OF INERTIA

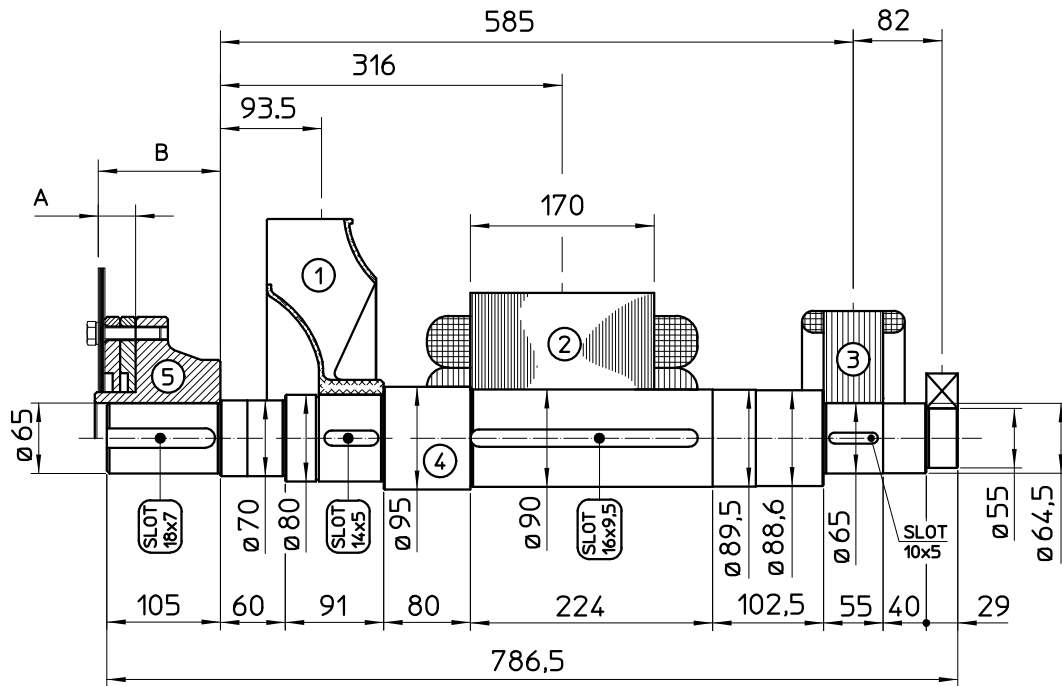

	COMPONENT	WEIGHT kg	J kgm <sup>2</sup>
1	FAN	3,3	0,0451
2	MAIN ROTOR	43	0,350
3	EX. ROTOR	14,5	0,0874
4	SHAFT	30,9	0,0274
	TOTAL	91,7	0,5099

SAE No	SHAFTS COUPLING FLEX PLATE			
	A	B	WEIGHT kg	J kgm <sup>2</sup>
10	46,5	112,8	20,5	0,1342
11,5	37,3	98,6	19,3	0,1512
14	27,4	84,4	21,1	0,2752

## SINGLE BEARING DIMENSIONS

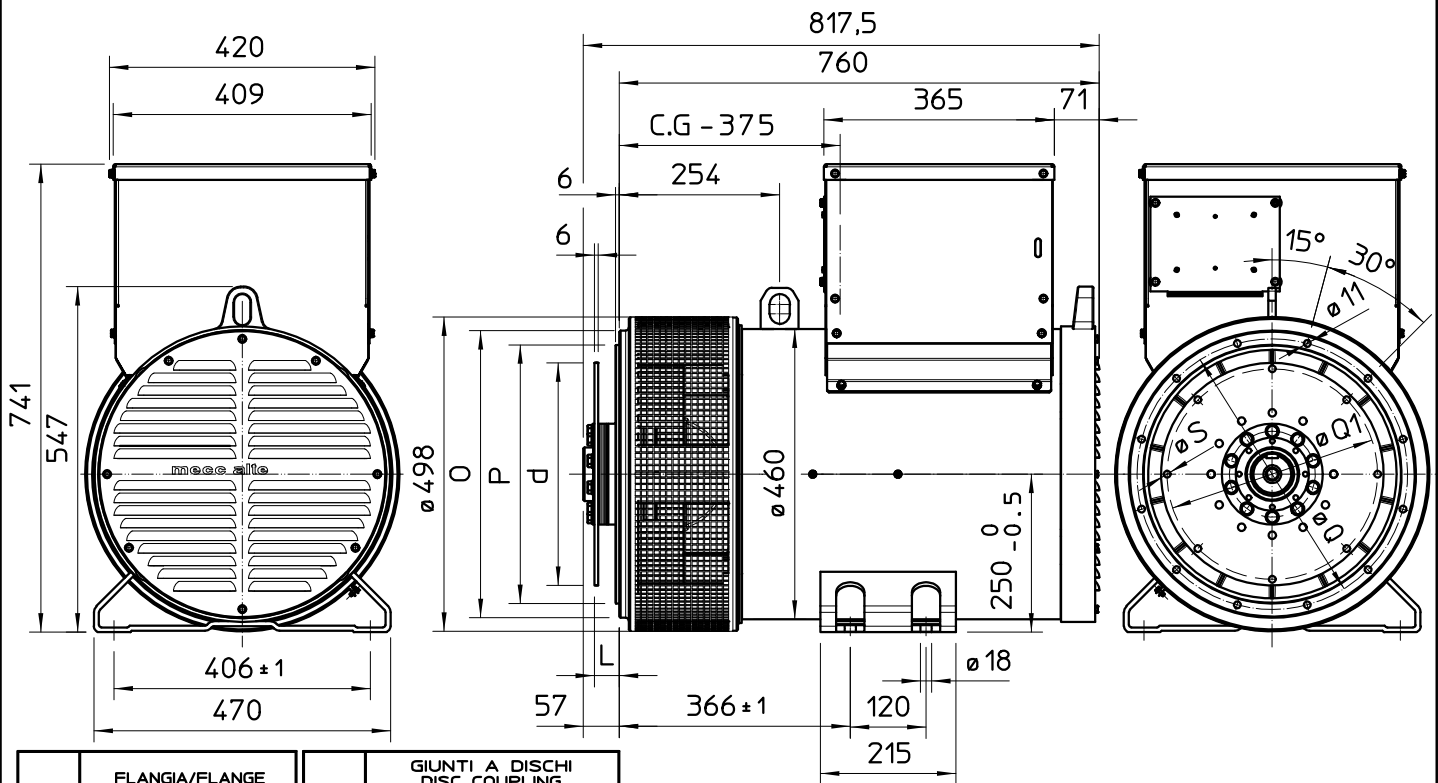

SAE Z.	FLANGIA/FLANGE BRIDE/FLANSCH				SAE Z.	GIUNTI A DISCHI DISC COUPLING DISQUE DE MONOPALIER SCHEIBENKUPPLUNG				
	O	P	Q	N. fori		L	d	Q1	N. fori	S
3	451	409,6	428,6	12	10	53,8	314,32	295,27	8	11
2	489	447,7	466,7	12	11 1/2	39,6	352,42	333,37	8	11
1	552	511,2	530,2	12	14	25,4	466,72	438,15	8	14

C.G. = GRAVITY CENTER