

Electrical Characteristics										
Frequency	Hz	50				60				
Voltage (star)	V	380	400	415	440	415	440	460	480	
Rated power class H	kVA	31,5	31,5	31,5	27	32	36	38	38	
	kW	25,2	25,2	25,2	21,6	25,6	28,8	30,4	30,4	
Rated power class F	kVA	30	30	30	25,5	30	34	36	36	
	kW	24	24	24	20,4	24	27,2	28,8	28,8	
Regulation with	SR7/2	±1,5 % with any power factor and speed variations between -5% +30%								
Insulation class		H								
Execution		Brushless								
Stator winding		12 ends								
Rotor		with damping cage								
Efficiencies class H (see graph. for details)	4/4	%	86,8	87,2	87,5	84,2	88,3	88,6	88,8	89,2
	3/4	%	87,5	87,8	87,9	84,6	89,2	89,4	89,6	89,8
	2/4	%	85,4	85,5	85,5	82,4	87,2	87,3	87,4	87,5
	1/4	%	82,2	82	82	79,8	83,2	83,2	83,2	83
Reactances (f. l.cl. F)	Xd	%	265,9	240	223,0	170,0	270,4	270,6	261,3	240
	Xd'	%	8,31	7,5	6,97	5,3	8,45	8,46	8,17	7,5
	Xd''	%	4,32	3,9	3,62	2,8	4,39	4,40	4,25	3,9
	Xq	%	141,7	127,9	118,8	90,6	144,1	144,2	139,3	127,9
	Xq'	%	141,7	127,9	118,8	90,6	144,1	144,2	139,3	127,9
	Xq''	%	23,9	21,6	20,1	15,3	24,3	24,4	23,5	21,6
	X ₂	%	14,07	12,7	11,80	9,0	14,31	14,32	13,83	12,7
	X ₀	%	4,88	4,4	4,09	3,1	4,96	4,96	4,79	4,4
Short Circuit Ratio	Kcc		0,90	1	1,20	1,30	0,78	0,83	0,90	1,00
Time Constants	Td'	sec.	0,040							
	Td''	sec.	0,013							
	Tdo'	sec.	0,75							
	Tα	sec.	0,057							
Short Circuit Current Capacity	%	>300				>350				
Excitation at no load	Amp.	0,3	0,4	0,5	0,60	0,2	0,25	0,3	0,4	
Excitation at full load	Amp.	1,4	1,6	1,7	1,80	1,2	1,3	1,4	1,5	
Overload (long-term)	%	1 hour in a 6 hours period 110% rated load								
Overload per 20 sec.	%	300								
Stator Winding Resistance (20°C)	Ω	0,086								
Rotor Winding Resistance (20°C)	Ω	5,848								
Exciter Resistance (20 °C)	Ω	Rotor : 0,64				Stator : 10,60				
Heat dissipation at f.l.cl.H	W	3832	3699	3600	4053	3392	3706	3834	3681	
Telephone Interference		THF < 2%				TIF < 45				
Radio interference		EN50081-1, EN50082-1, VDE0875K. For others standards apply to factory								
Waveform Distors.(THD) at f. load	LL/LN %	2,8 / 3								
Waveform Distors.(THD) at no load	LL/LN %	2,7 / 2,9								
Mechanical characteristics										
Protection		IP 23 (other protection on request)								
DE bearing		6309-2RS								
NDE bearing		6209-2RS								
Weight of wound stator assembly	kg	51,9								
Weight of wound rotor assembly	kg	27,6								
Weight of complete generator	kg	141								
Maximun overspeed	rpm	4500								
Unbalanced magnetic pull at f.l.cl.F	kN/mm	3,8								
Cooling air requirement	m³/min	9,7				11				
Inertia Constant (H)	sec.	0,171				0,204				
Noise level at 1m/7m	dB(A)	86 / 74				90,5 / 78				

All technical data are to be considered as a reference and they can be modified without any notice

This document is a propriety of Mecc Alte S.p.a..All rights reserved.

50 Hz

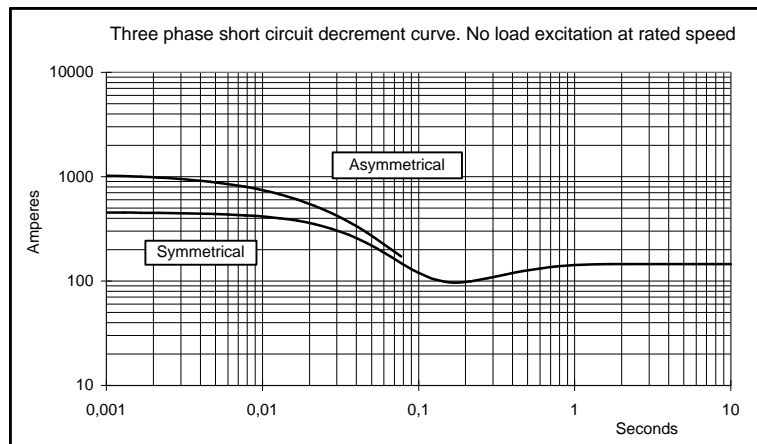
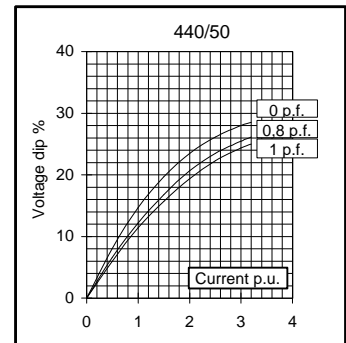
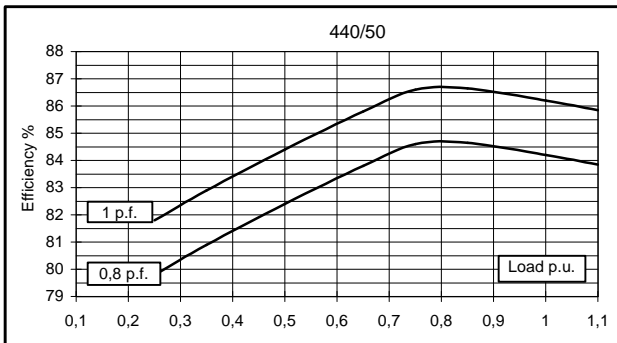
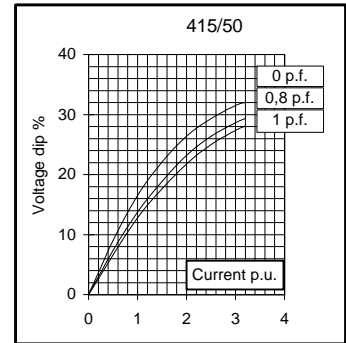
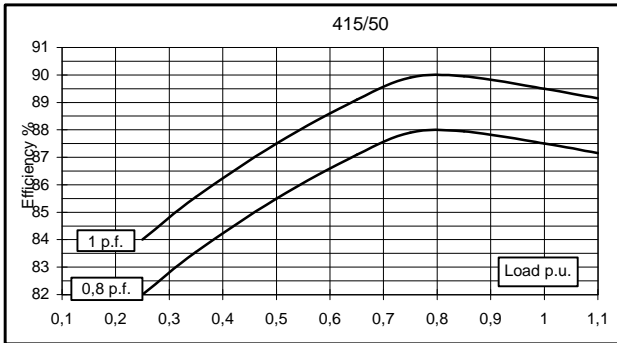
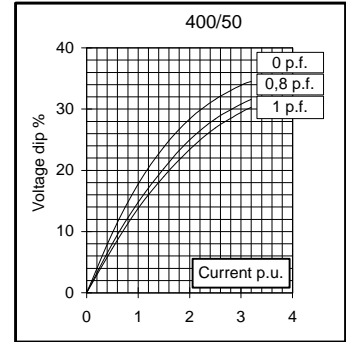
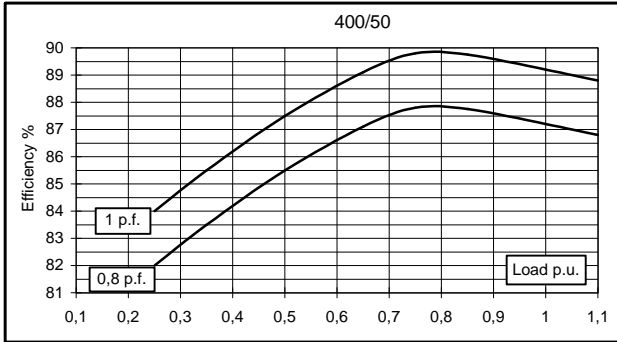
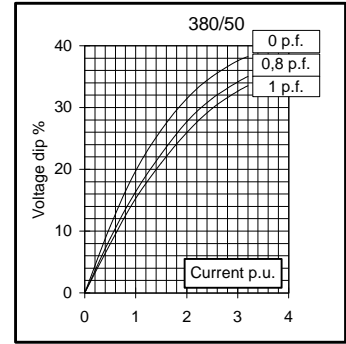
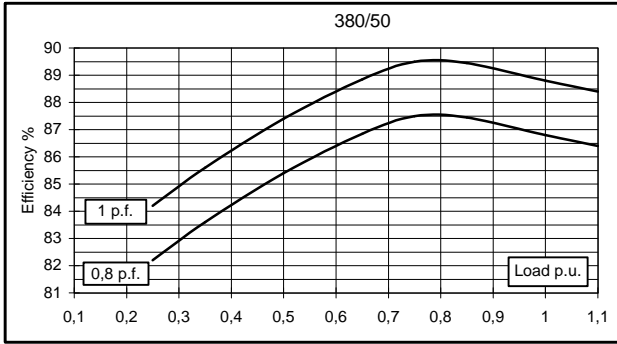

60 Hz

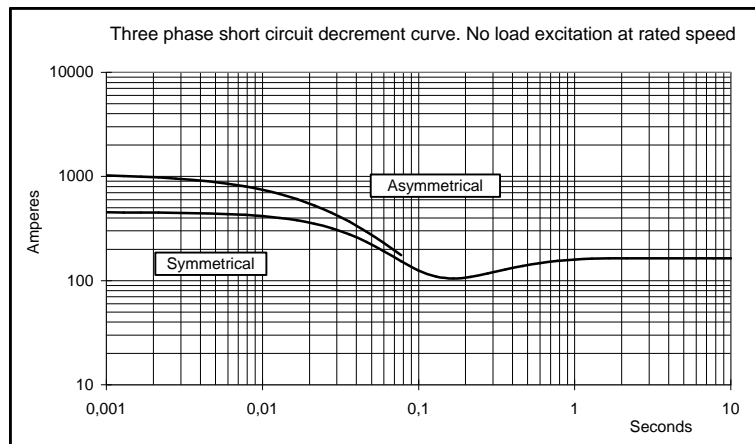
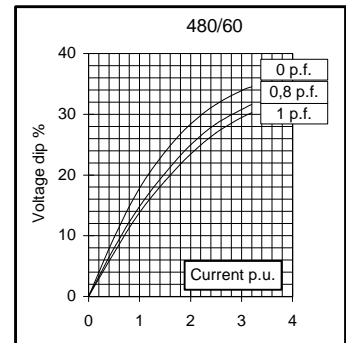
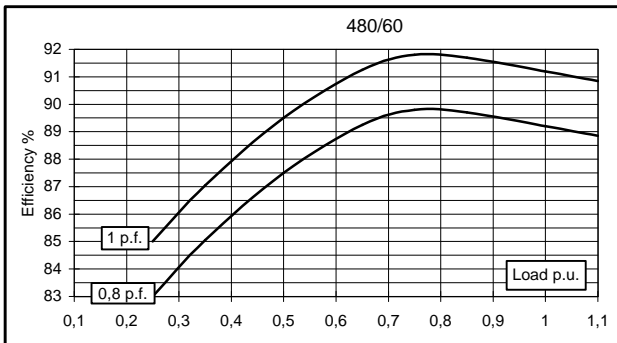
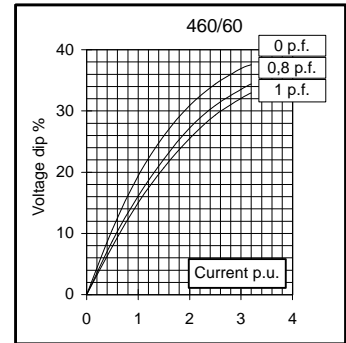
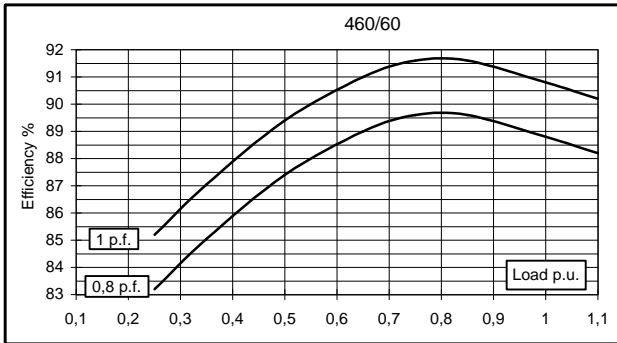
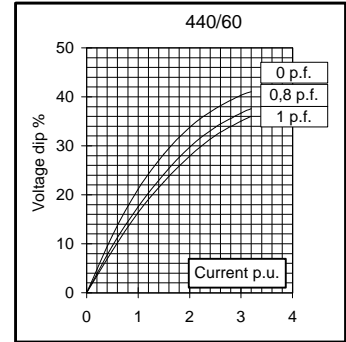
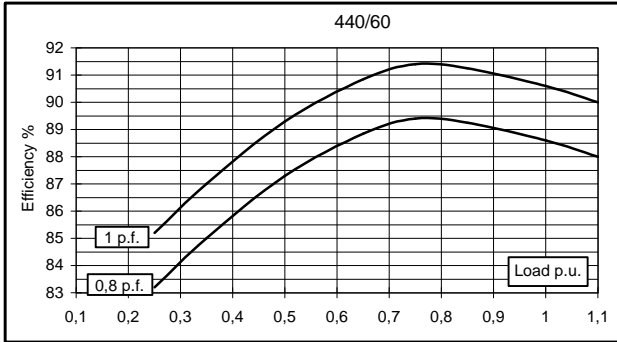
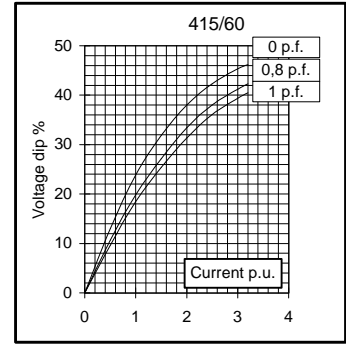
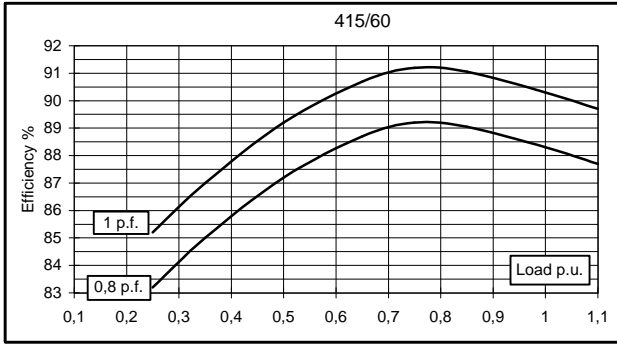

SINGLE BEARING MOMENTS OF INERTIA

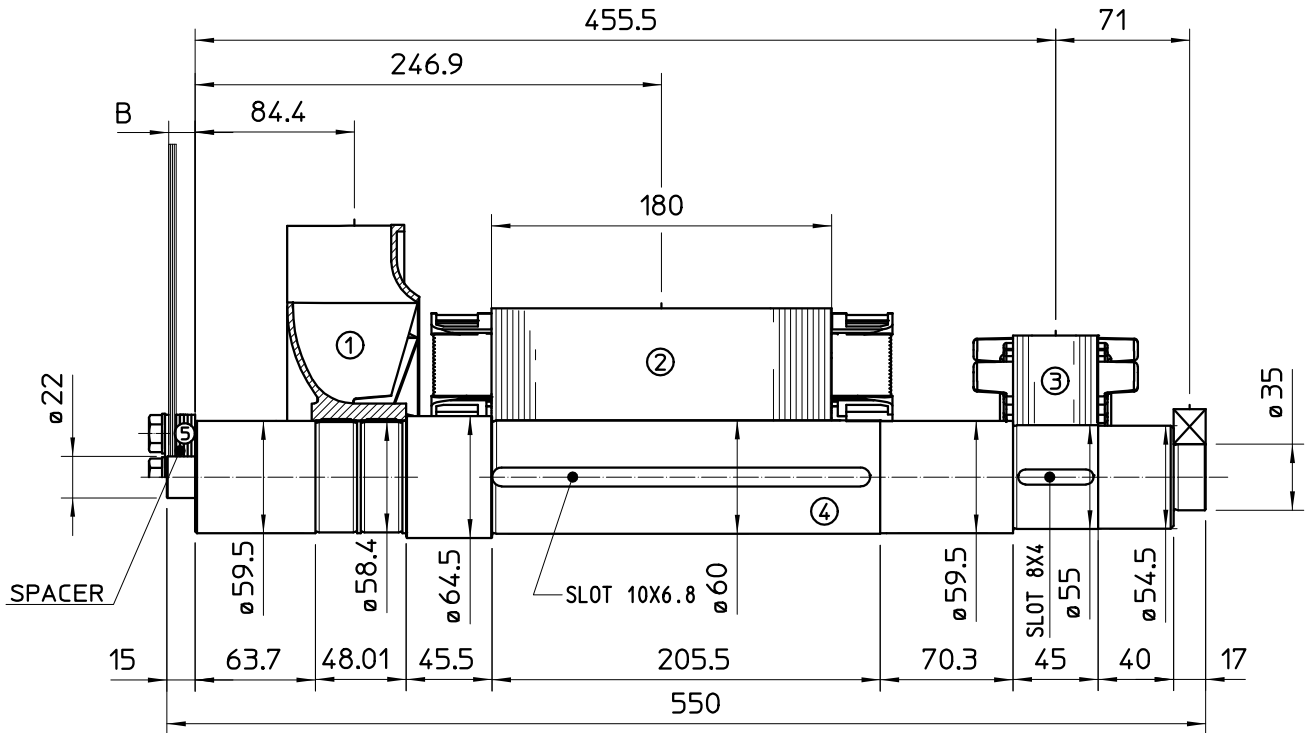

COMPONENT	WEIGHT Kg	J Kg ^m ²
1 FAN	1.2	0.0102
2 MAIN ROTOR	23.4	0.082
3 EX ROTOR	5.4	0.012
4 SHAFT	10.6	0.0044
6 TOTAL	40.6	0.1086

SAE N.	SHAFT COUPLING FLEX PLATE		
	B (mm)	WEIGHT kg	J kg ^m ²
5			
6 1/2	4	1.14	0.0067
7 1/2	4	1.42	0.0103
8	35.6	1.97	0.0171
10	27.6	2.59	0.0319
11 1/2	14	3.1	0.0481

SINGLE BEARING DIMENSIONS

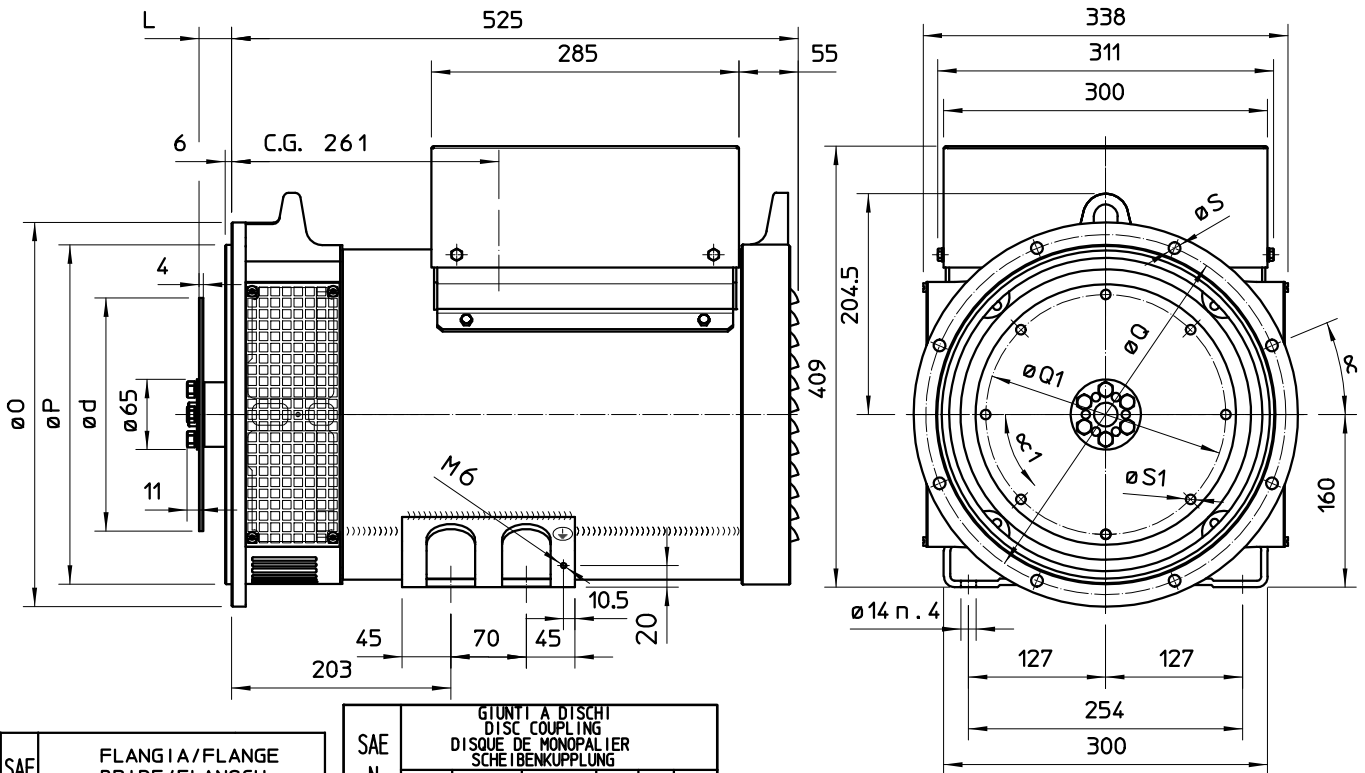

SAE N.	FLANGIA/FLANGE BRIDE/FLANSCH					
	O	P	Q	n. fori	S	α
5	356	314.3	333.4	8	11	22°30'
4	403	362	381	12	11	15°
3	451	409.6	428.6	12	11	15°
2	489	447.7	466.7	12	11	15°

SAE N.	GIUNTI A DISCHI DISC COUPLING DISQUE DE MONOPALIER SCHEIBENKUPPLUNG					
	L	d	Q1	n. fori	S1	α1
6 1/2	30.2	215.9	200	6	9	60°
7 1/2	30.2	241.3	222.25	8	9	45°
8	62	263.52	244.47	6	11	60°
10	53.8	314.32	295.27	8	11	45°
11 1/2	39.6	352.42	333.37	8	11	45°

C.G. = GRAVITY CENTER